

**DANA ALOKASI KHUSUS (DAK)
KABUPATEN KARANGANYAR**



**PROGRAM :
PENYELENGGARAAN JALAN**

DOKUMEN GAMBAR PERENCANAAN

**NAMA PAKET PEKERJAAN :
BELANJA JASA KONSULTANSI DESAIN PERENCANAAN DAK 2023**

NAMA RUAS :

MALANGGATEN - BUNTAR 112

TAHUN ANGGARAN 2023

LEMBAR PENGESAHAN

NAMA PAKET : BELANJA JASA KONSULTANSI DESAIN PERENCANAAN DAK 2023

Kami Bertanggung Jawab Atas
Dokumen Perencanaan Ini
Penyedia Jasa
CV. GEMILANG KONSULTAN

SUYATNO
Direktur

Mengetahui :
Kepala Bidang Bina Marga DPUR
Kab. Karanganyar

MARGONO ST.,MT.
NIP. 19730104 200604 1 005

Mengesahkan :
Kepala Dinas Pekerjaan Umum Dan Perumahan Rakyat
Kabupaten Karanganyar

ASHINO PURWADI, S.T.
NIP.19720828 199803 1 016

DAFTAR ISI

NO.	NAMA GAMBAR	SKALA
01	PETA LOKASI PEKERJAAN	-
02	LAYOUT EXISTING L 1:10, P 1:2100	1 : 2100
03	LAYOUT RENCANA L 1:10, P 1:2100	1 : 2100
04	STA 0+000 - STA 0+125	H 1:50 V 1:10
05	STA 0+125 - STA 0+250	H 1:50 V 1:10
06	STA 0+250 - STA 0+375	H 1:50 V 1:10
07	STA 0+375 - STA 0+500	H 1:50 V 1:10
08	STA 0+500 - STA 0+625	H 1:50 V 1:10
09	STA 0+625 - STA 0+750	H 1:50 V 1:10
10	STA 0+750 - STA 0+875	H 1:50 V 1:10
11	STA 0+875 - STA 1+000	H 1:50 V 1:10
12	STA 1+000 - STA 1+125	H 1:50 V 1:10
13	STA 1+125 - STA 1+250	H 1:50 V 1:10
14	STA 1+250 - STA 1+375	H 1:50 V 1:10
15	STA 1+375 - STA 1+500	H 1:50 V 1:10

NO.	NAMA GAMBAR	SKALA
16	STA 1+500 - STA 1+625	H 1:50 V 1:10
17	STA 1+625 - STA 1+750	H 1:50 V 1:10
18	STA 1+750 - STA 1+875	H 1:50 V 1:10
19	STA 1+875 - STA 2+000	H 1:50 V 1:10
20	STA 2+000 - STA 2+125	H 1:50 V 1:10
21	STA 2+125 - STA 2+250	H 1:50 V 1:10
22	STA 2+250 - STA 2+375	H 1:50 V 1:10
23	STA 2+375 - STA 2+500	H 1:50 V 1:10
24	STA 2+500 - STA 2+625	H 1:50 V 1:10
25	STA 2+625 - STA 2+750	H 1:50 V 1:10
26	STA 2+750 - STA 2+875	H 1:50 V 1:10
27	STA 2+875 - STA 3+000	H 1:50 V 1:10
28	STA 3+000 - STA 3+125	H 1:50 V 1:10
29	STA 3+125 - STA 3+250	H 1:50 V 1:10
30	STA 3+250 - STA 3+375	H 1:50 V 1:10

DAFTAR ISI

NO.	NAMA GAMBAR	SKALA
31	STA 3+375 - STA 0+500	H 1:50 V 1:10
32	STA 3+500 - STA 3+625	H 1:50 V 1:10
33	STA 3+625 - STA 3+750	H 1:50 V 1:10
34	STA 3+750 - STA 3+875	H 1:50 V 1:10
35	STA 3+875 - STA 4+000	H 1:50 V 1:10
36	STA 4+000 - STA 4+125	H 1:50 V 1:10
37	STA 4+125 - STA 4+250	H 1:50 V 1:10
38	STA 4+250 - STA 4+375	H 1:50 V 1:10
39	STA 4+375 - STA 4+500	H 1:50 V 1:10
40	STA 4+500 - STA 4+625	H 1:50 V 1:10
41	STA 4+625 - STA 4+750	H 1:50 V 1:10
42	STA 4+750 - STA 4+875	H 1:50 V 1:10
43	STA 4+875 - STA 5+000	H 1:50 V 1:10
44	STA 5+000 - STA 5+125	H 1:50 V 1:10
45	STA 5+125 - STA 5+250	H 1:50 V 1:10

NO.	NAMA GAMBAR	SKALA
46	STA 5+250 - STA 5+375	H 1:50 V 1:10
47	STA 5+375 - STA 5+500	H 1:50 V 1:10
48	STA 5+500 - STA 5+625	H 1:50 V 1:10
49	STA 5+625 - STA 5+750	H 1:50 V 1:10
50	STA 5+750 - STA 5+875	H 1:50 V 1:10
51	STA 5+875 - STA 6+000	H 1:50 V 1:10
52	STA 6+000 - STA 6+125	H 1:50 V 1:10
53	STA 6+125 - STA 6+200	H 1:50 V 1:10
54	TYPIKAL POTONGAN MELINTANG ASPAL	1 : 50
55	TYPIKAL POTONGAN MELINTANG BETON	1 : 50
56	TYPIKAL POTONGAN MELINTANG BETON	1 : 50
57	TYPIKAL POTONGAN MELINTANG ASPAL	1 : 50
58	TYPIKAL POTONGAN MELINTANG BETON	1 : 50
59	DETAIL MODUL DOWEL	1 : 100
60	DETAIL PEMASANGAN DOWEL	1 : 10
	DETAL OPRIT JALAN MASUK BETON	1 : 100
	DETAIL TALUD PASANGAN BATU	1 : 30



PETA LOKASI PEKERJAAN

Jl. Malangaten - Buntar

Ruas : 112



DINAS PEKERJAAN UMUM
DAN PERUMAHAN RAKYAT
KABUPATEN KARANGANYAR

No. Paket :-
No. Ruas : 112
Nama Ruas :Jl. Malanggaten - Buntar
Provinsi : Jawa Tengah



CV. GEMILANG KONSULTAN

Digambar	Direncanakan	Diperiksa
MUKTI PUJI WIDODO, ST	BASUKI RAHMAT, ST	TEDDY KRESWANTO, ST

JUDUL GAMBAR :

PETA LOKASI PEKERJAAN

No Lembar : 01

Jml Lembar : 62

Skala : -

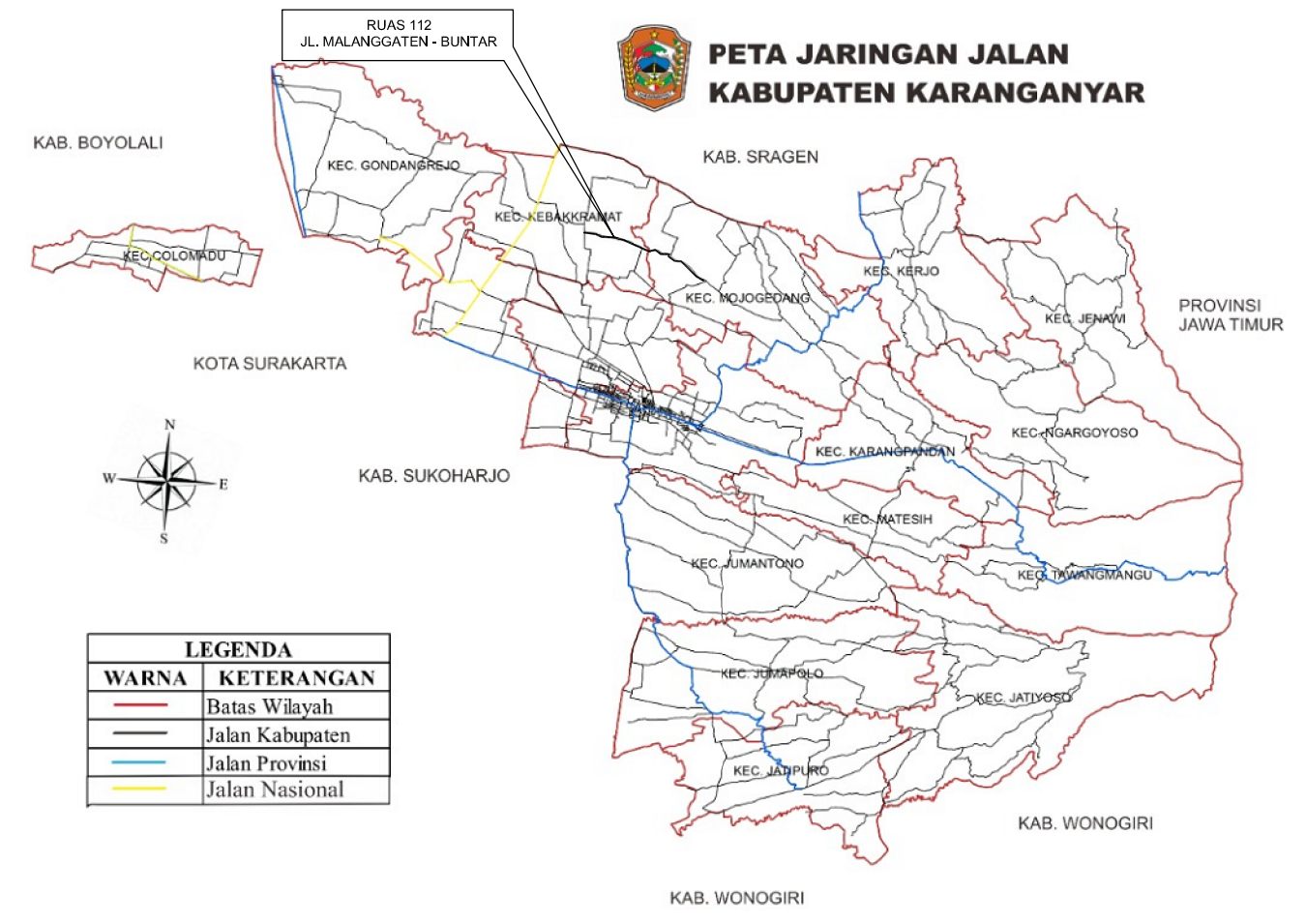
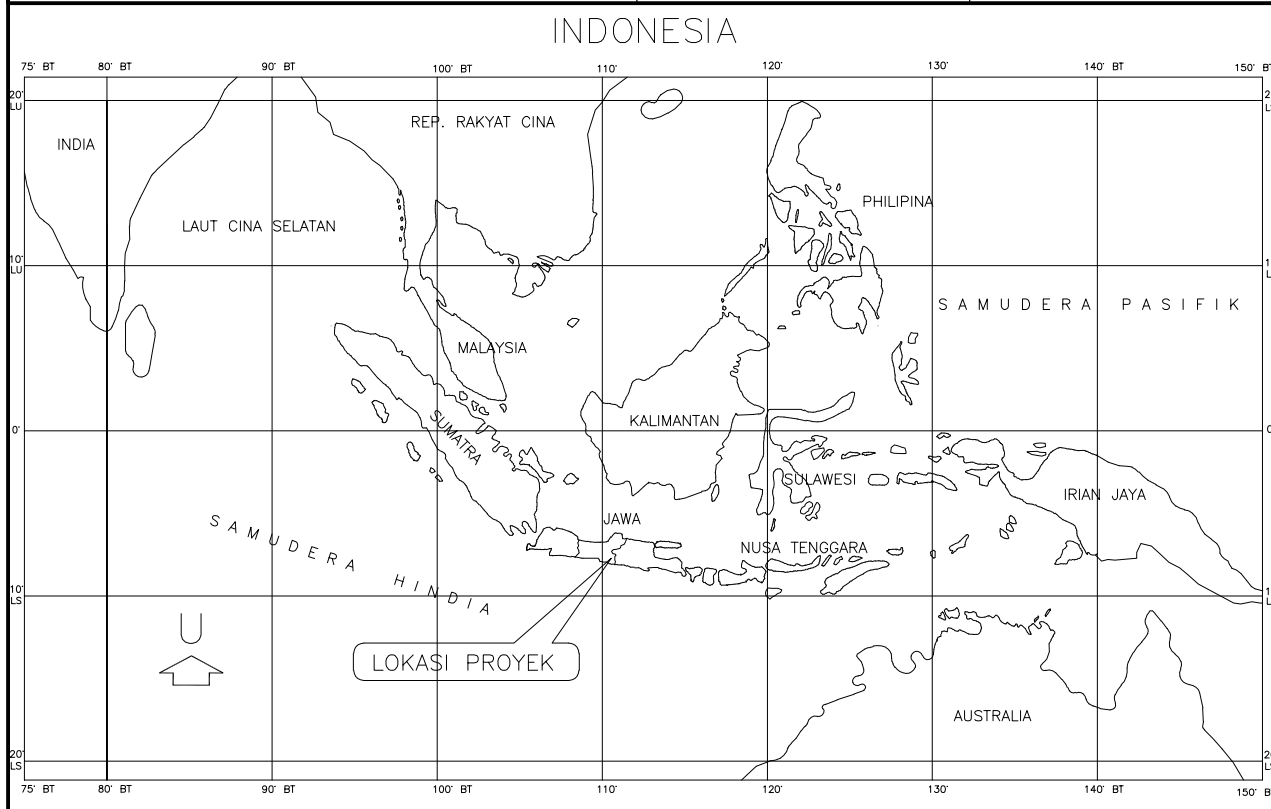



LAYOUT / STRIPMAP

Jl. Malangaten - Buntar

Ruas : 112



DINAS PEKERJAAN UMUM
DAN PERUMAHAN RAKYAT
KABUPATEN KARANGANYAR

No. Paket :-
No. Ruas : 112
Nama Ruas : Jl. Malangaten - Buntar
Provinsi : Jawa Tengah



CV. GEMILANG KONSULTAN

Digambar	Direncanakan	Diperiksa
MUKTI PUJI WIDODO, ST	BASUKI RAHMAT, ST	TEDDY KRESWANTO, ST

JUDUL GAMBAR :

LAYOUT PLAN
EXISTING

No Lembar : 02

Jml Lembar : 62

Skala : 1 : 16000

LEGENDA	
	Pemukiman Penduduk
	Hutan
	Sekolah
	Persawahan
	Masjid

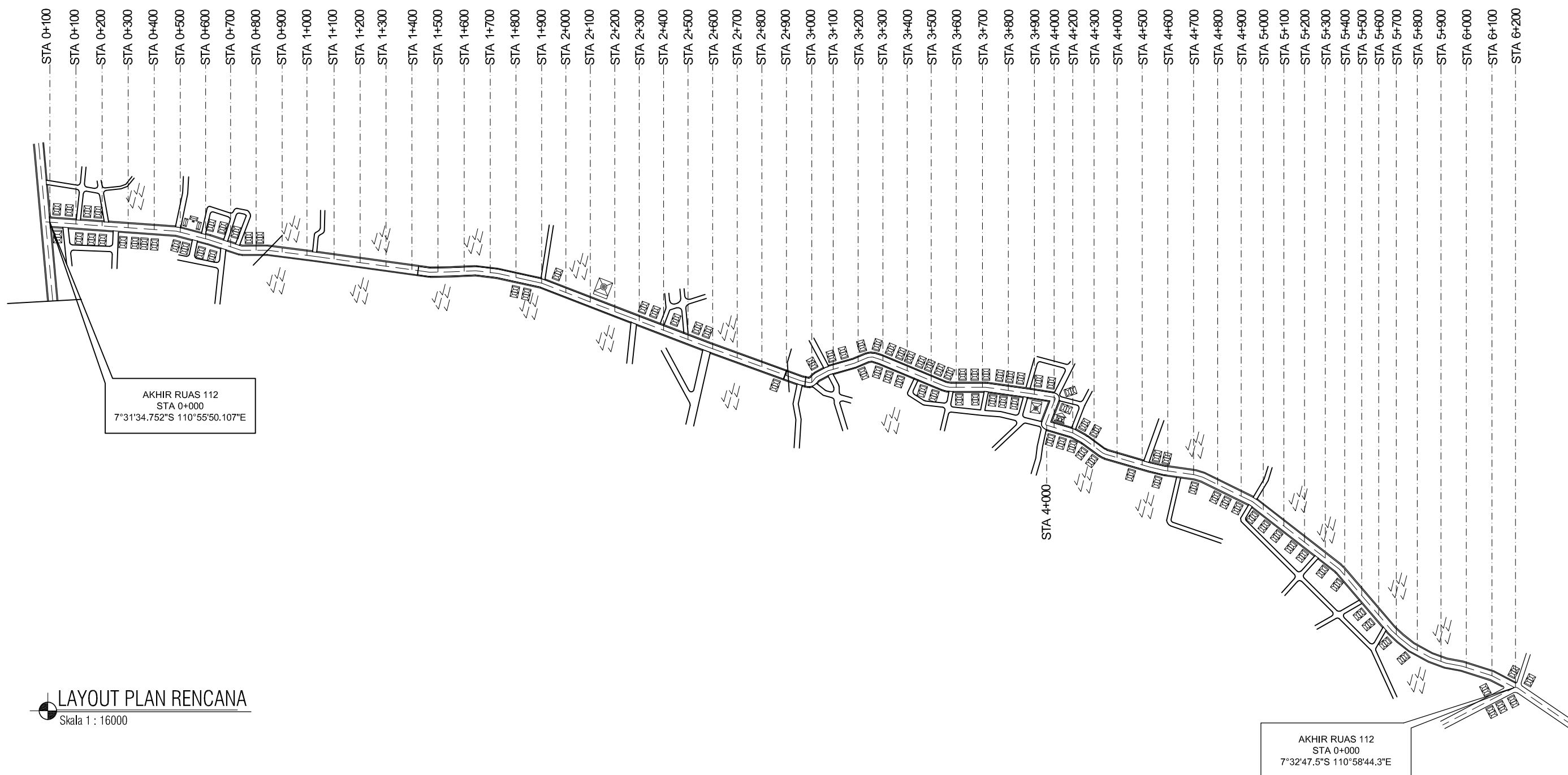

LAYOUT PLAN RENCANA
Skala 1 : 16000

AKHIR RUAS 112
STA 0+000
7°32'47.5\"/>



DINAS PEKERJAAN UMUM
DAN PERUMAHAN RAKYAT
KABUPATEN KARANGANYAR

No. Paket :-
No. Ruas : 112
Nama Ruas : Jl. Malanggan - Buntar
Provinsi : Jawa Tengah



CV. GEMILANG KONSULTAN

Digambar	Direncanakan	Diperiksa
MUKTI PUJI WIDODO, ST	BASUKI RAHMAT, ST	TEDDY KRESWANTO, ST

JUDUL GAMBAR :

LAYOUT PLAN
RENCANA

No Lembar : 03

Jml Lembar : 62

Skala : 1 : 16000

KETERANGAN

1. Pekerjaan Laston Lapis Aus AC - WC Tbl. 4 cm dan Laston Lapis Antara (AC-BC) Tbl. 6 cm
STA 0+400 -0+525
1. Pekerjaan Laston Lapis Aus AC - WC Tbl. 4 cm
STA 2+950-4+600
2. Perkerasan Beton Fc'25 Mpa Dengan Anyaman Tul. Tunggal
STA 1+058 - 1+125
STA 1+437 - 2+950
STA 4+600 - 5+173
3. Pekerjaan Talud Batu Kali
(Pada Tabel)

LEGENDA

- | | |
|--|--------------------|
| | Pemukiman Penduduk |
| | Hutan |
| | Sekolah |
| | Persawahan |
| | Masjid |

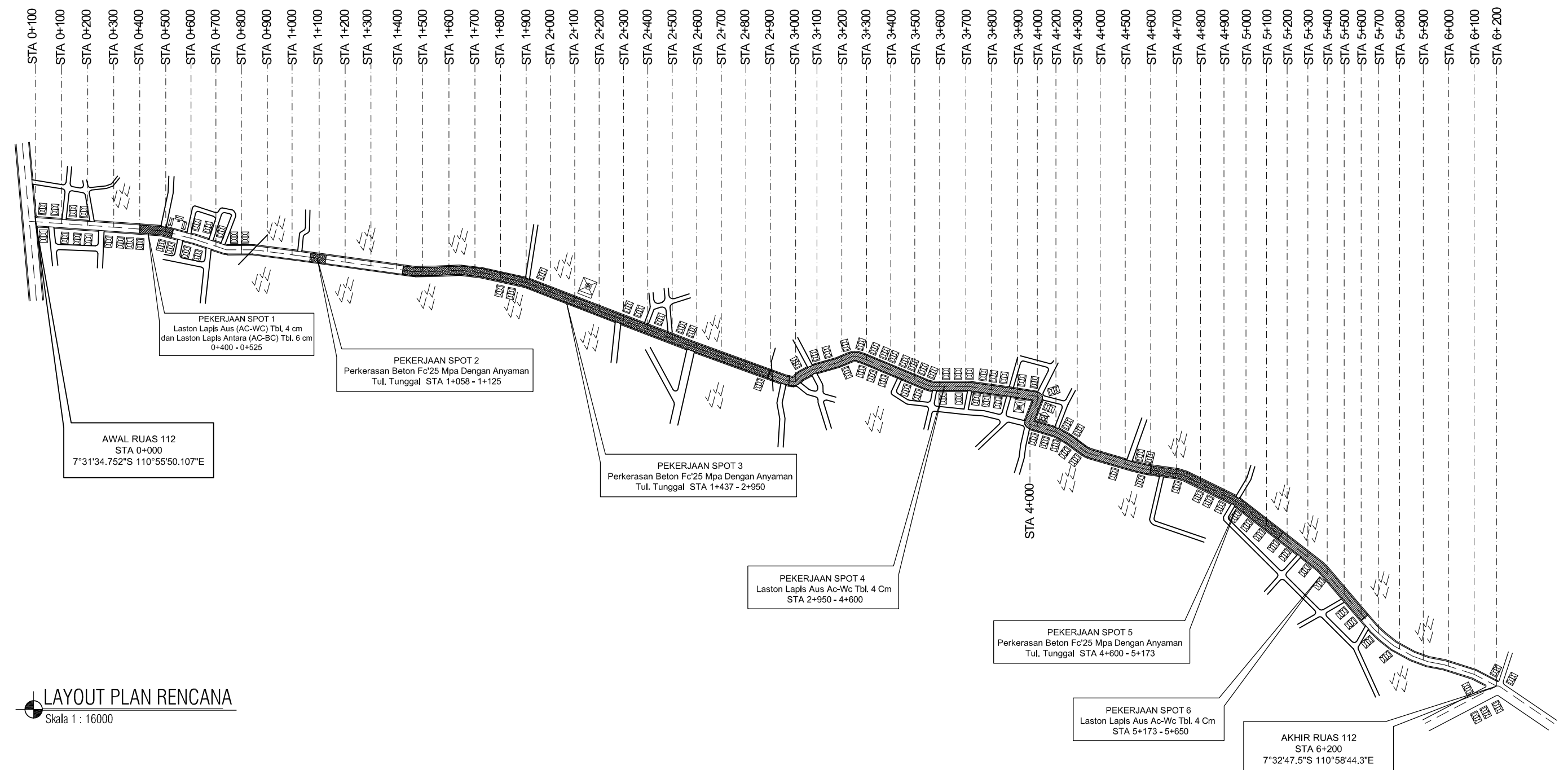
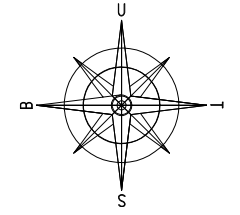

LAYOUT PLAN RENCANA

Skala 1 : 16000



DINAS PEKERJAAN UMUM
DAN PERUMAHAN RAKYAT
KABUPATEN KARANGANYAR

No. Paket :-
No. Ruas : 112
Nama Ruas : Jl. Malangaten - Buntar
Provinsi : Jawa Tengah



CV. GEMILANG KONSULTAN
DIGAMBAR : MUKTI PUJI WIDODO, ST
DIRENCANAKAN : BASUKI RAHMAT, ST
DIPERIKSA : TEDDY KRESWANTO, ST

JUDUL GAMBAR :
STA 0 + 750 - STA 0 + 875

No Lembar : 10
Jml Lembar : 62
Skala : H 1 : 50
V 1 : 10

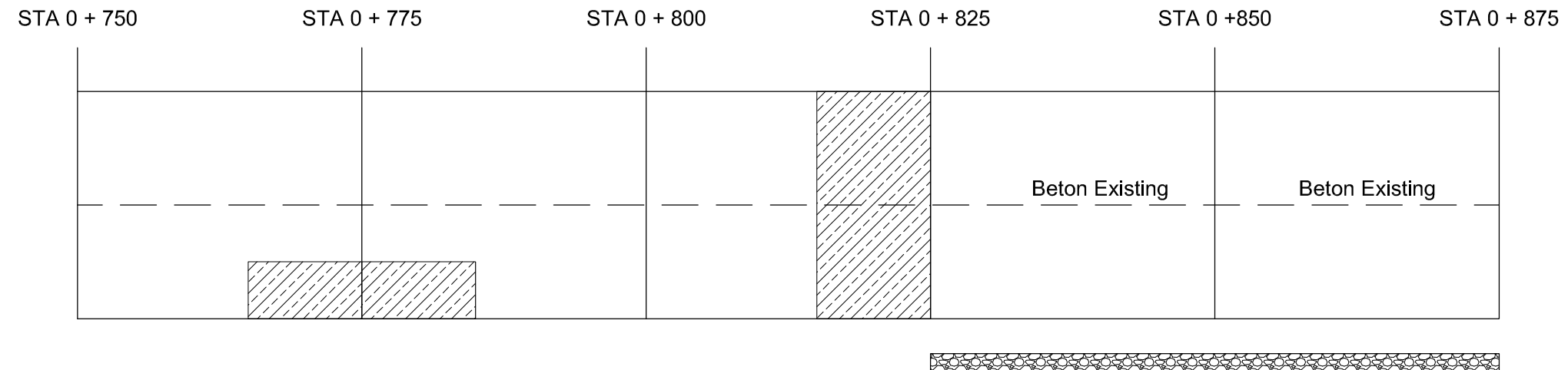

BADAN JALAN [PENAMPANG LURUS]		KETERANGAN :								
Skala : Horizontal : 1 : 50 Vertikal : 1 : 10			Perkerasan Beton Fc' 25 Mpa dengan anyaman Tul. Tunggal Tbl. 20 cm							
			AC-WC 4 cm							
			AC-WC 4 cm dan AC-BC 6 cm							
			Leveling / Normalisasi							
			Berm Timbunan Pilihan dari sumber galian Tbl. 30 cm							
			Talud Pasangan Batu							
JENIS PEKERJAAN		SAT	STA 0 + 750	STA 0 + 775	STA 0 + 800	STA 0 + 825	STA 0 + 850	STA 0 + 875	JUMLAH	KOMULATIF
Lapis Pondasi Agregat Kelas A	M3	0.40		0.40		2.00	-	-	2.80	12.70
Lapis Pondasi bawah Beton Kuras	M3	-		-		-	-	-	-	-
Lapis Perekat - Aspal Cair/Emulsi	Liter	-		-		-	-	-	-	160.00
Laston Lapis Aus (AC-WC)	Ton	-		-		-	-	-	-	45.60
Laston Lapis Antara (AC-BC)	Ton	-		-		-	-	-	-	68.40
Beton struktur, fc'25 Mpa	M3	-		-		-	-	-	-	-
Perbaikan Campuran Aspal Panas	M3	0.40		0.40		2.00	-	-	2.80	10.70
N/A	N/A	-		-		-	-	-	-	-
N/A	N/A	-		-		-	-	-	-	-



DINAS PEKERJAAN UMUM
DAN PERUMAHAN RAKYAT
KABUPATEN KARANGANYAR

No. Paket :-
No. Ruas : 112
Nama Ruas : Jl. Malangaten - Buntar
Provinsi : Jawa Tengah



CV. GEMILANG KONSULTAN

Digambar	Direncanakan	Diperiksa
MUKTI PUJI WIDODO, ST	BASUKI RAHMAT, ST	TEDDY KRESWANTO, ST

JUDUL GAMBAR :

STA 1 + 625 - STA 1 + 750

No Lembar : 17
Jml Lembar : 62
Skala : H 1 : 50
V 1 : 10

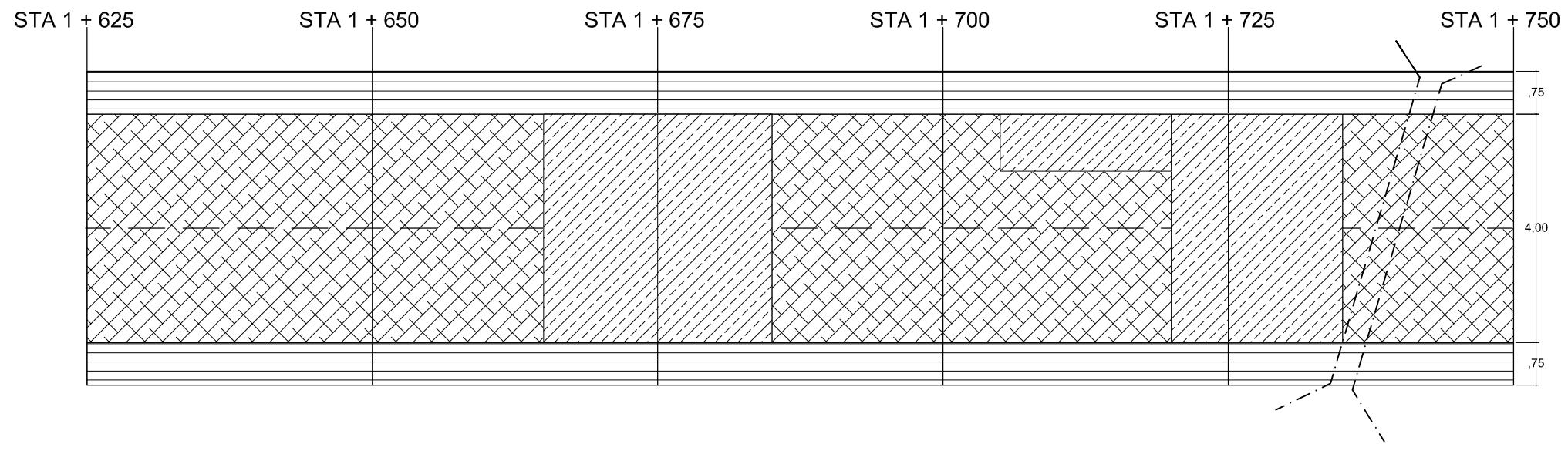

<p>Berm</p> <h2>BADAN JALAN</h2> <p>[PENAMPANG LURUS]</p> <p>Skala : Horizontal : 1 : 50 Vertikal : 1 : 10</p> <p>Berm</p>										<p>KETERANGAN :</p> <ul style="list-style-type: none"> = Perkerasan Beton Fc' 25 Mpa dengan anyaman Tul. Tunggal Tbl. 20 cm = AC-WC 4 cm = AC-WC 4 cm dan AC-BC 6 cm = Leveling / Normalisasi = Berm Timbunan Pilihan dari sumber galian Tbl. 30 cm = Talud Pasangan Batu

		STA 1 + 625	STA 1 + 650	STA 1 + 675	STA 1 + 700	STA 1 + 725	STA 1 + 750	JUMLAH	KOMULATIF
JENIS PEKERJAAN	SAT								
Lapis Pondasi Agregat Kelas A	M3	-	2.80	2.80	3.50	4.00	13.10	25.80	
Lapis Pondasi bawah Beton Kurus	M3	10.50	10.50	10.50	10.50	10.50	52.50	162.12	
Lapis Perekat - Aspal Cair/Emulsi	Liter	-	-	-	-	-	-	180.00	
Laston Lapis Aus (AC-WC)	Ton	-	-	-	-	-	-	54.72	
Laston Lapis Antara (AC-BC)	Ton	-	-	-	-	-	-	68.40	
Beton struktur, fc'25 Mpa	M3	20.00	20.00	20.00	20.00	20.00	100.00	308.80	
Perbaikan Campuran Aspal Panas	M3	-	-	-	-	-	-	10.70	
N/A	N/A	-	-	-	-	-	-	-	
N/A	N/A	-	-	-	-	-	-	-	



DINAS PEKERJAAN UMUM
DAN PERUMAHAN RAKYAT
KABUPATEN KARANGANYAR

No. Paket :-
No. Ruas : 112
Nama Ruas : Jl. Malangaten - Buntar
Provinsi : Jawa Tengah



CV. GEMILANG KONSULTAN

Digambar	Direncanakan	Diperiksa
MUKTI PUJI WIDODO, ST	BASUKI RAHMAT, ST	TEDDY KRESWANTO, ST

JUDUL GAMBAR :

STA 1 + 750 - STA 1 + 875

No Lembar : 18
Jml Lembar : 62
Skala : H 1 : 50
V 1 : 10

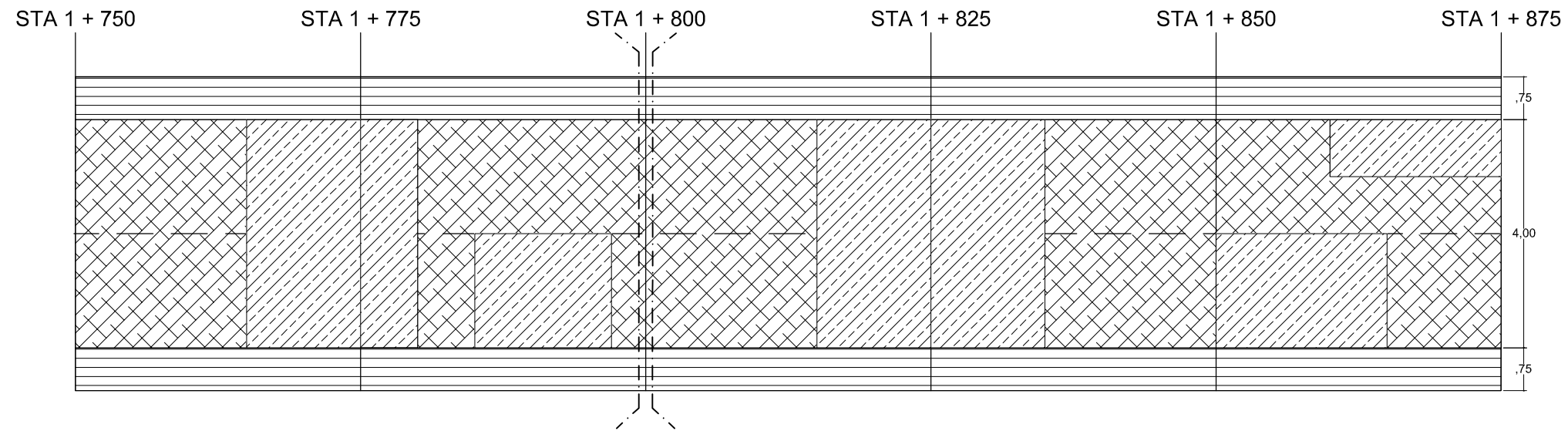

BADAN JALAN

[PENAMPANG LURUS]

Skala :
Horizontal : 1 : 50
Vertikal : 1 : 10

KETERANGAN :

- = Perkerasan Beton Fc' 25 Mpa dengan anyaman Tul.Tunggal Tbl. 20 cm
- = AC-WC 4 cm
- = AC-WC 4 cm dan AC-BC 6 cm
- = Leveling / Normalisasi
- = Berm Timbunan Pilihan dari sumber galian Tbl. 30 cm
- = Talud Pasangan Batu

JENIS PEKERJAAN	SAT	STA 1 + 750	STA 1 + 775	STA 1 + 800	STA 1 + 825	STA 1 + 850	STA 1 + 875	JUMLAH	KOMULATIF
Lapis Pondasi Agregat Kelas A	M3	2.80	3.80	2.00	2.00	2.25		12.85	38.65
Lapis Pondasi bawah Beton Korus	M3	10.50	10.50	10.50	10.50	10.50		52.50	214.62
Lapis Perekat - Aspal Cair/Emulsi	Liter	-	-	-	-	-		-	180.00
Laston Lapis Aus (AC-WC)	Ton	-	-	-	-	-		-	54.72
Laston Lapis Antara (AC-BC)	Ton	-	-	-	-	-		-	68.40
Beton struktur, fc'25 Mpa	M3	20.00	20.00	20.00	20.00	20.00		100.00	408.80
Perbaikan Campuran Aspal Panas	M3	-	-	-	-	-		-	10.70
N/A	N/A	-	-	-	-	-		-	-
N/A	N/A	-	-	-	-	-		-	-



DINAS PEKERJAAN UMUM
DAN PERUMAHAN RAKYAT
KABUPATEN KARANGANYAR

No. Paket :-
No. Ruas : 112
Nama Ruas : Jl. Malangaten - Buntar
Provinsi : Jawa Tengah



CV. GEMILANG KONSULTAN

Digambar	Direncanakan	Diperiksa
MUKTI PUJI WIDODO, ST	BASUKI RAHMAT, ST	TEDDY KRESWANTO, ST

JUDUL GAMBAR :

STA 1 + 875 - STA 2 + 000

No Lembar : 19

Jml Lembar : 62

Skala : H 1 : 50
V 1 : 10

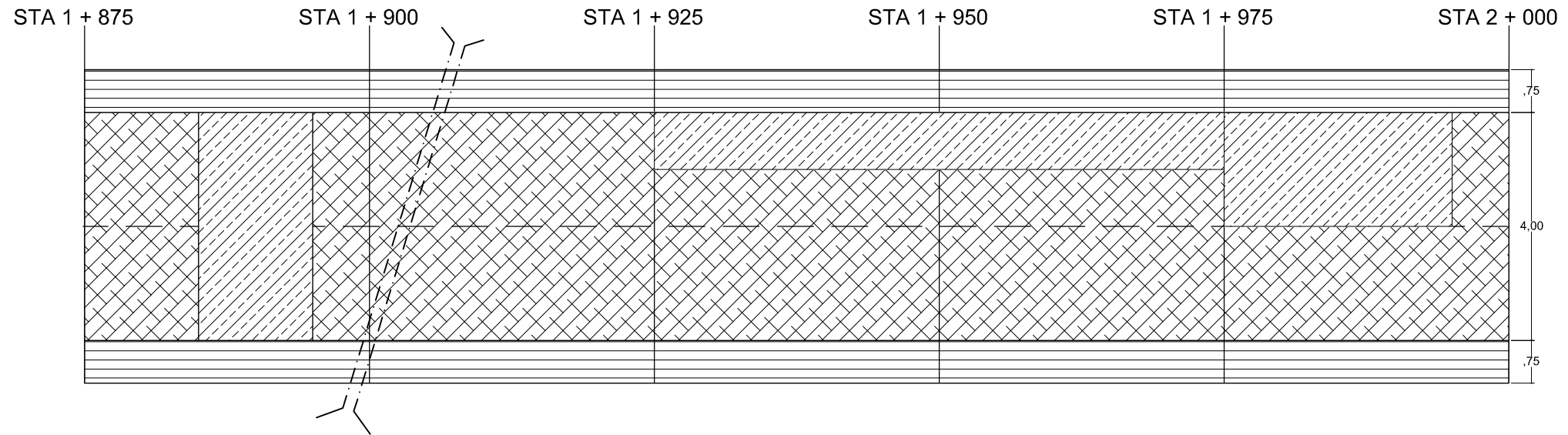

BADAN JALAN [PENAMPANG LURUS]		KETERANGAN :								
Berm Skala : Horizontal : 1 : 50 Vertikal : 1 : 10 Berm			Perkerasan Beton Fc' 25 Mpa dengan anyaman Tul. Tunggal Tbl. 20 cm							
			AC-WC 4 cm							
			AC-WC 4 cm dan AC-BC 6 cm							
			Leveling / Normalisasi							
			Berm Timbunan Pilihan dari sumber galian Tbl. 30 cm							
			Talud Pasangan Batu							
		STA 1 + 875	STA 1 + 900	STA 1 + 925	STA 1 + 950	STA 1 + 975	STA 2 + 000	JUMLAH	KOMULATIF	
JENIS PEKERJAAN	SAT									
Lapis Pondasi Agregat Kelas A	M3	4.00	1.00	1.00	2.80	-	8.80	47.45		
Lapis Pondasi bawah Beton Kuras	M3	10.50	10.50	10.50	10.50	10.50	52.50	267.12		
Lapis Perekat - Aspal Cair/Emulsi	Liter	-	-	-	-	-	-	180.00		
Laston Lapis Aus (AC-WC)	Ton	-	-	-	-	-	-	54.72		
Laston Lapis Antara (AC-BC)	Ton	-	-	-	-	-	-	68.40		
Beton struktur, fc'25 Mpa	M3	20.00	20.00	20.00	20.00	20.00	100.00	508.80		
Perbaikan Campuran Aspal Panas	M3	-	-	-	-	-	-	10.70		
N/A	N/A	-	-	-	-	-	-	-		
N/A	N/A	-	-	-	-	-	-	-		



DINAS PEKERJAAN UMUM
DAN PERUMAHAN RAKYAT
KABUPATEN KARANGANYAR

No. Paket :-
No. Ruas : 112
Nama Ruas : Jl. Malangaten - Buntar
Provinsi : Jawa Tengah



CV. GEMILANG KONSULTAN

Digambar	Direncanakan	Diperiksa
MUKTI PUJI WIDODO, ST	BASUKI RAHMAT, ST	TEDDY KRESWANTO, ST

JUDUL GAMBAR :

STA 2 + 125 - STA 2 + 250

No Lembar : 21
Jml Lembar : 62
Skala : H 1 : 50
V 1 : 10

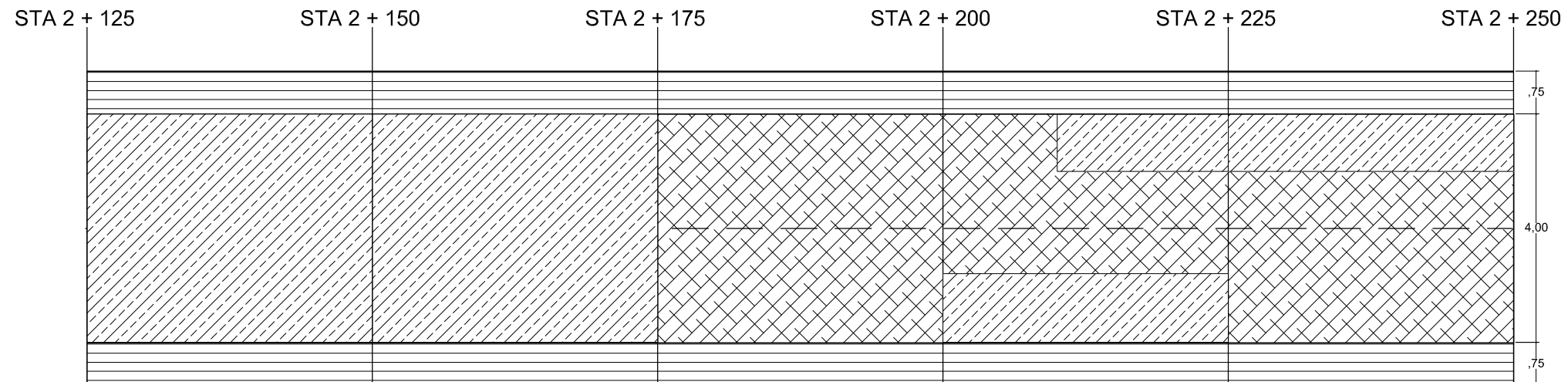

<p>Berm</p> <h2>BADAN JALAN</h2> <p>[PENAMPANG LURUS]</p> <p>Skala : Horizontal : 1 : 50 Vertikal : 1 : 10</p> <p>Berm</p>							<p>KETERANGAN :</p> <ul style="list-style-type: none"> = Perkerasan Beton Fc' 25 Mpa dengan anyaman Tul. Tunggul Tbl. 20 cm = AC-WC 4 cm = AC-WC 4 cm dan AC-BC 6 cm = Leveling / Normalisasi = Berm Timbunan Pilihan dari sumber galian Tbl. 30 cm = Talud Pasangan Batu

		STA 2 + 125	STA 2 + 150	STA 2 + 175	STA 2 + 200	STA 2 + 225	STA 2 + 250	JUMLAH	KOMULATIF
JENIS PEKERJAAN	SAT								
Lapis Pondasi Agregat Kelas A	M3	5.00	5.00	-	2.25	1.25	13.50	83.90	
Lapis Pondasi bawah Beton Korus	M3	10.50	10.50	10.50	10.50	10.50	52.50	372.12	
Lapis Perekat - Aspal Cair/Emulsi	Liter	-	-	-	-	-	-	180.00	
Laston Lapis Aus (AC-WC)	Ton	-	-	-	-	-	-	54.72	
Laston Lapis Antara (AC-BC)	Ton	-	-	-	-	-	-	68.40	
Beton struktur, fc'25 Mpa	M3	20.00	20.00	20.00	20.00	20.00	100.00	708.80	
Perbaikan Campuran Aspal Panas	M3	-	-	-	-	-	-	10.70	
N/A	N/A	-	-	-	-	-	-	-	
N/A	N/A	-	-	-	-	-	-	-	



DINAS PEKERJAAN UMUM
DAN PERUMAHAN RAKYAT
KABUPATEN KARANGANYAR

No. Paket :-
No. Ruas : 112
Nama Ruas : Jl. Malangaten - Buntar
Provinsi : Jawa Tengah



CV. GEMILANG KONSULTAN

Digambar	Direncanakan	Diperiksa
MUKTI PUJI WIDODO, ST	BASUKI RAHMAT, ST	TEDDY KRESWANTO, ST

JUDUL GAMBAR :

STA 2 + 500 - STA 2 + 625

No Lembar : 24
Jml Lembar : 62
Skala : H 1 : 50
V 1 : 10

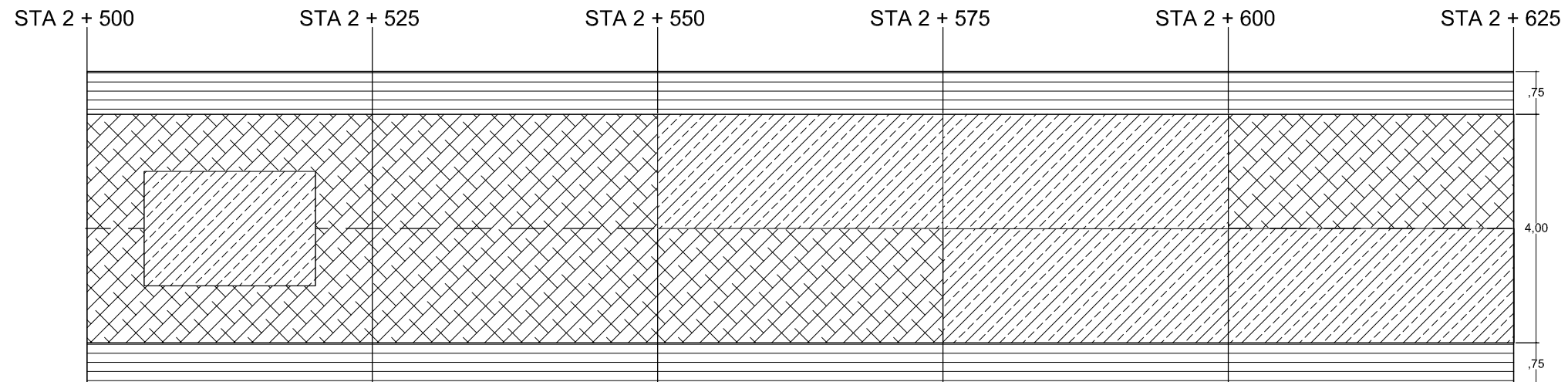

<p>Berm</p> <h2>BADAN JALAN</h2> <p>[PENAMPANG LURUS]</p> <p>Skala : Horizontal : 1 : 50 Vertikal : 1 : 10</p>							<p>KETERANGAN :</p> <ul style="list-style-type: none"> = Perkerasan Beton Fc' 25 Mpa dengan anyaman Tul.Tunggal Tbl. 20 cm = AC-WC 4 cm = AC-WC 4 cm dan AC-BC 6 cm = Leveling / Normalisasi = Berm Timbunan Pilihan dari sumber galian Tbl. 30 cm = Talud Pasangan Batu
	Berm						

		STA 2 + 500	STA 2 + 525	STA 2 + 550	STA 2 + 575	STA 2 + 600	STA 2 + 625	JUMLAH	KOMULATIF
JENIS PEKERJAAN	SAT								
Lapis Pondasi Agregat Kelas A	M3	1.20	-	2.50	7.50	5.00	16.20	111.95	
Lapis Pondasi bawah Beton Korus	M3	10.50	10.50	10.50	10.50	10.50	52.50	529.62	
Lapis Perekat - Aspal Cair/Emulsi	Liter	-	-	-	-	-	-	180.00	
Laston Lapis Aus (AC-WC)	Ton	-	-	-	-	-	-	54.72	
Laston Lapis Antara (AC-BC)	Ton	-	-	-	-	-	-	68.40	
Beton struktur, fc'25 Mpa	M3	20.00	20.00	20.00	20.00	20.00	100.00	1,008.80	
Perbaikan Campuran Aspal Panas	M3	-	-	-	-	-	-	10.70	
N/A	N/A	-	-	-	-	-	-	-	
N/A	N/A	-	-	-	-	-	-	-	



DINAS PEKERJAAN UMUM
DAN PERUMAHAN RAKYAT
KABUPATEN KARANGANYAR

No. Paket :-
No. Ruas : 112
Nama Ruas : Jl. Malangaten - Buntar
Provinsi : Jawa Tengah



CV. GEMILANG KONSULTAN

Digambar	Direncanakan	Diperiksa
MUKTI PUJI WIDODO, ST	BASUKI RAHMAT, ST	TEDDY KRESWANTO, ST

JUDUL GAMBAR :

STA 2 + 750 - STA 2 + 875

No Lembar : 26

Jml Lembar : 62

Skala : H 1 : 50
V 1 : 10

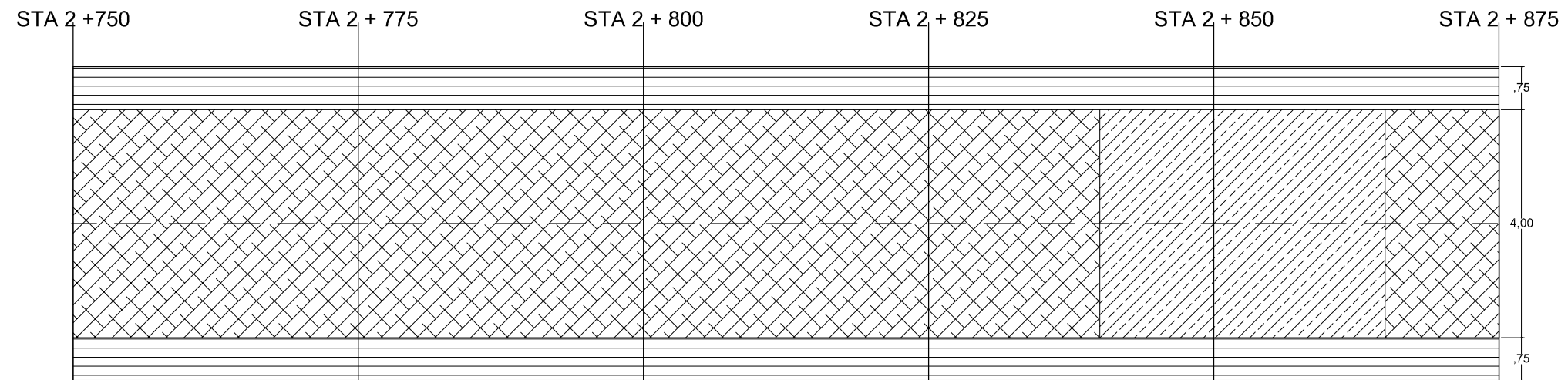

Berm

BADAN JALAN

[PENAMPANG LURUS]

Skala :
Horizontal : 1 : 50
Vertikal : 1 : 10

Berm

KETERANGAN :

- = Perkerasan Beton Fc' 25 Mpa dengan anyaman Tul. Tunggal Tbl. 20 cm
- = AC-WC 4 cm
- = AC-WC 4 cm dan AC-BC 6 cm
- = Leveling / Normalisasi
- = Berm Timbunan Pilihan dari sumber galian Tbl. 30 cm
- = Talud Pasangan Batu

STA 2 + 750

STA 2 + 775

STA 2 + 800

STA 2 + 825

STA 2 + 850

STA 2 + 875

JENIS PEKERJAAN	SAT	STA 2 + 750	STA 2 + 775	STA 2 + 800	STA 2 + 825	STA 2 + 850	STA 2 + 875	JUMLAH	KOMULATIF
Lapis Pondasi Agregat Kelas A	M3	-	-	-	8.00	12.00	20.00	131.95	
Lapis Pondasi bawah Beton Kurus	M3	10.50	10.50	10.50	10.50	10.50	52.50	634.62	
Lapis Perekat - Aspal Cair/Emulsi	Liter	-	-	-	-	-	-	180.00	
Laston Lapis Aus (AC-WC)	Ton	-	-	-	-	-	-	54.72	
Laston Lapis Antara (AC-BC)	Ton	-	-	-	-	-	-	68.40	
Beton struktur, fc'25 Mpa	M3	20.00	20.00	20.00	20.00	20.00	100.00	1,208.80	
Perbaikan Campuran Aspal Panas	M3	-	-	-	-	-	-	10.70	
N/A	N/A	-	-	-	-	-	-	-	
N/A	N/A	-	-	-	-	-	-	-	



DINAS PEKERJAAN UMUM
DAN PERUMAHAN RAKYAT
KABUPATEN KARANGANYAR

No. Paket :-
No. Ruas : 112
Nama Ruas : Jl. Malangaten - Buntar
Provinsi : Jawa Tengah



CV. GEMILANG KONSULTAN

Digambar	Direncanakan	Diperiksa
MUKTI PUJI WIDODO, ST	BASUKI RAHMAT, ST	TEDDY KRESWANTO, ST

JUDUL GAMBAR :

STA 4 + 125 - STA 4 + 250

No Lembar : 37

Jml Lembar : 62

Skala : H 1 : 50
V 1 : 10

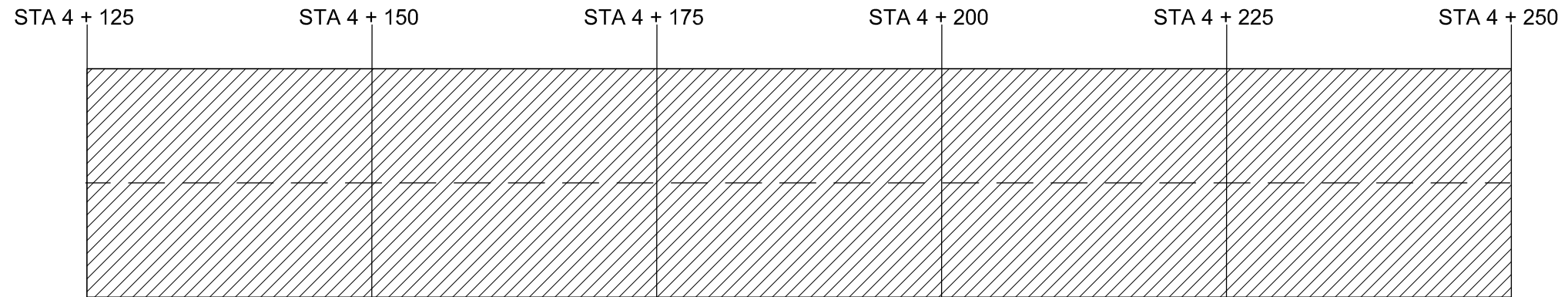

Berm							KETERANGAN :	
BADAN JALAN [PENAMPANG LURUS]							= Perkerasan Beton Fc' 25 Mpa dengan anyaman Tul. Tunggal Tbl. 20 cm	
							= AC-WC 4 cm	
Skala : Horizontal : 1 : 50 Vertikal : 1 : 10							= AC-WC 4 cm dan AC-BC 6 cm	
							= Leveling / Normalisasi	
Berm							= Berm Timbunan Pilihan dari sumber galian Tbl. 30 cm	
							= Talud Pasangan Batu	
		STA 4 + 125	STA 4 + 150	STA 4 + 175	STA 4 + 200	STA 4 + 225	STA 4 + 250	
JENIS PEKERJAAN	SAT						JUMLAH	KOMULATIF
Lapis Pondasi Agregat Kelas A	M3	-	-	-	-	-	-	131.95
Lapis Pondasi bawah Beton Kurus	M3	-	-	-	-	-	-	666.12
Lapis Perekat - Aspal Cair/Emulsi	Liter	20.00	20.00	20.00	20.00	20.00	100.00	1,220.00
Laston Lapis Aus (AC-WC)	Ton	9.12	9.12	9.12	9.12	9.12	45.60	528.96
Laston Lapis Antara (AC-BC)	Ton	-	-	-	-	-	-	68.40
Beton struktur, fc'25 Mpa	M3	-	-	-	-	-	-	1,268.80
Perbaikan Campuran Aspal Panas	M3	-	-	-	-	-	-	14.45
N/A	N/A	-	-	-	-	-	-	-
N/A	N/A	-	-	-	-	-	-	-



DINAS PEKERJAAN UMUM
DAN PERUMAHAN RAKYAT
KABUPATEN KARANGANYAR

No. Paket :-
No. Ruas : 112
Nama Ruas : Jl. Malanggan - Buntar
Provinsi : Jawa Tengah



CV. GEMILANG KONSULTAN

Digambar	Direncanakan	Diperiksa
MUKTI PUJI WIDODO, ST	BASUKI RAHMAT, ST	TEDDY KRESWANTO, ST

JUDUL GAMBAR :

STA 5 + 000 - STA 5 + 125

No Lembar : 44

Jml Lembar : 62

Skala : H 1 : 50
V 1 : 10

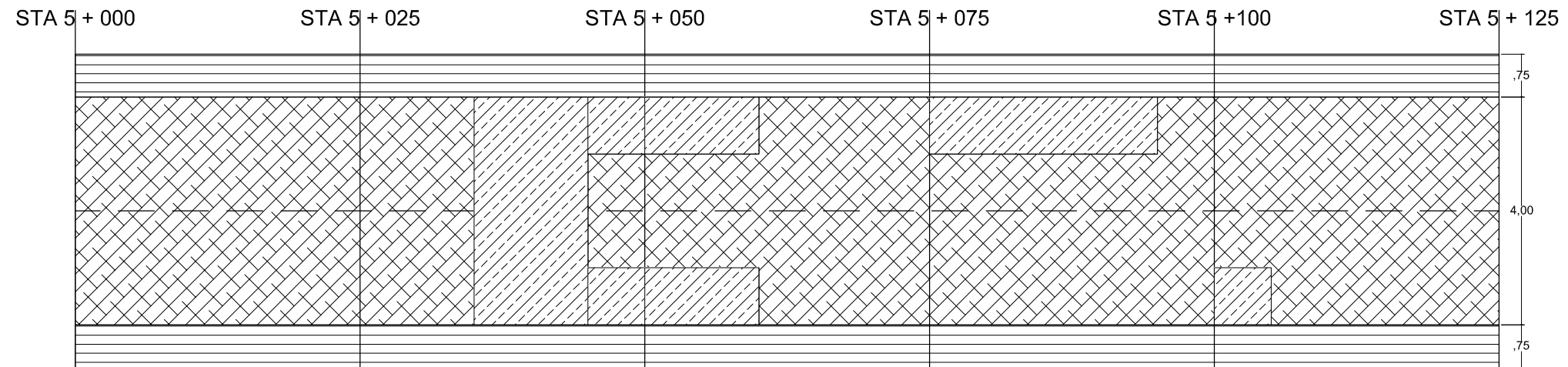

Berm

BADAN JALAN

[PENAMPANG LURUS]

Skala :
Horizontal : 1 : 50
Vertikal : 1 : 10

Berm

KETERANGAN :

- = Perkerasan Beton Fc' 25 Mpa dengan anyaman Tul. Tunggul Tbl. 20 cm
- = AC-WC 4 cm
- = AC-WC 4 cm dan AC-BC 6 cm
- = Leveling / Normalisasi
- = Berm Timbunan Pilihan dari sumber galian Tbl. 30 cm
- = Talud Pasangan Batu

STA 5 + 000

STA 5 + 025

STA 5 + 050

STA 5 + 075

STA 5 + 100

STA 5 + 125

JENIS PEKERJAAN	SAT	STA 5 + 000	STA 5 + 025	STA 5 + 050	STA 5 + 075	STA 5 + 100	STA 5 + 125	JUMLAH	KOMULATIF
Lapis Pondasi Agregat Kelas A	M3	-	4.70	1.40	1.40	0.20		7.70	182.95
Lapis Pondasi bawah Beton Korus	M3	10.50	10.50	10.50	10.50	10.50		52.50	886.62
Lapis Perekat - Aspal Cair/Emulsi	Liter	-	-	-	-	-		-	1,500.00
Laston Lapis Aus (AC-WC)	Ton	-	-	-	-	-		-	656.64
Laston Lapis Antara (AC-BC)	Ton	-	-	-	-	-		-	68.40
Beton struktur, fc'25 Mpa	M3	20.00	20.00	20.00	20.00	20.00		100.00	1,688.80
Perbaikan Campuran Aspal Panas	M3	-	-	-	-	-		-	15.34
N/A	N/A	-	-	-	-	-		-	-
N/A	N/A	-	-	-	-	-		-	-



DINAS PEKERJAAN UMUM
DAN PERUMAHAN RAKYAT
KABUPATEN KARANGANYAR

No. Paket :-
No. Ruas : 112
Nama Ruas : Jl. Malangaten - Buntar
Provinsi : Jawa Tengah



CV. GEMILANG KONSULTAN

Digambar	Direncanakan	Diperiksa
MUKTI PUJI WIDODO, ST	BASUKI RAHMAT, ST	TEDDY KRESWANTO, ST

JUDUL GAMBAR :

STA 6 + 750 - STA 6 + 875

No Lembar : 50
Jml Lembar : 62
Skala : H 1 : 50
 V 1 : 10

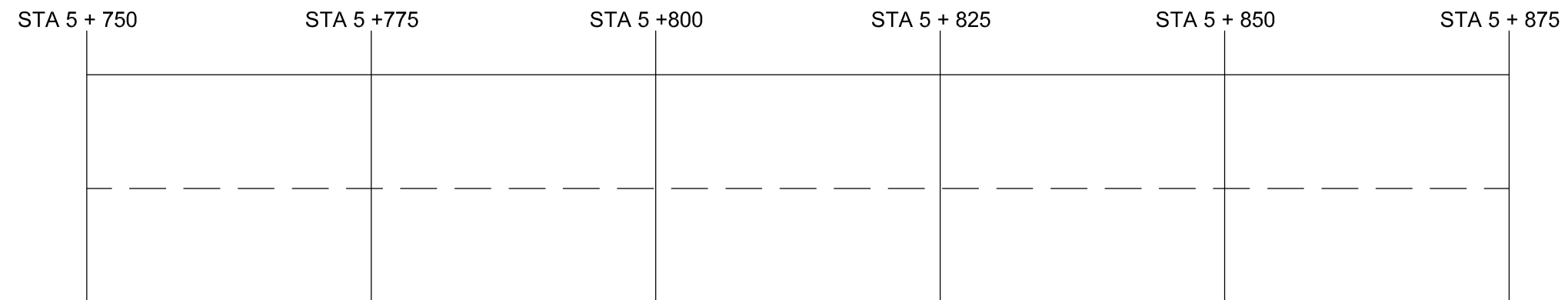

Berm

BADAN JALAN

[PENAMPANG LURUS]

Skala :
Horizontal : 1 : 50
Vertikal : 1 : 10

Berm

KETERANGAN :

- = Perkerasan Beton Fc' 25 Mpa dengan anyaman Tul. Tunggal Tbl. 20 cm
- = AC-WC 4 cm
- = AC-WC 4 cm dan AC-BC 6 cm
- = Leveling / Normalisasi
- = Berm Timbunan Pilihan dari sumber galian Tbl. 30 cm
- = Talud Pasangan Batu

STA 5 + 750

STA 5 + 775

STA 5 + 800

STA 5 + 825

STA 5 + 850

STA 5 + 875



DINAS PEKERJAAN UMUM
DAN PERUMAHAN RAKYAT
KABUPATEN KARANGANYAR

No. Paket :-
No. Ruas : 112
Nama Ruas : Jl. Malangaten - Buntar
Provinsi : Jawa Tengah



CV. GEMILANG KONSULTAN

Digambar	Direncanakan	Diperiksa
MUKTI PUJI WIDODO, ST	BASUKI RAHMAT, ST	TEDDY KRESWANTO, ST

JUDUL GAMBAR :

STA 6 + 875 - STA 6 + 000

No Lembar : 51
Jml Lembar : 62
Skala : H 1 : 50
 V 1 : 10

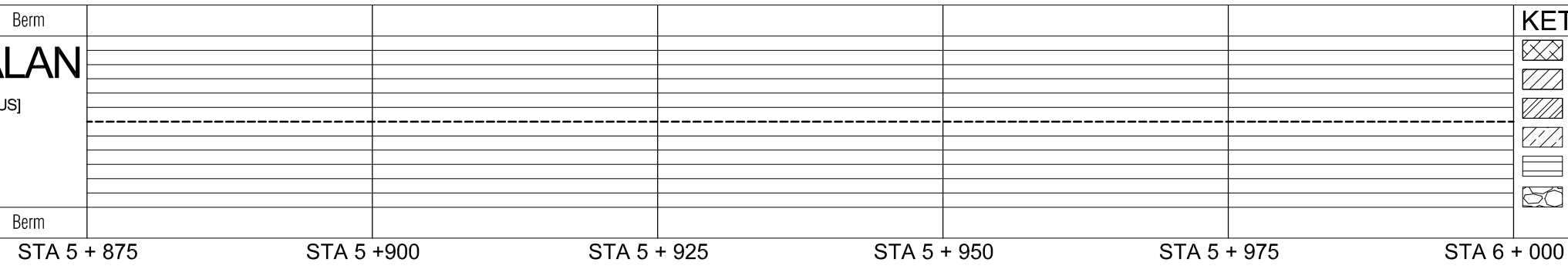
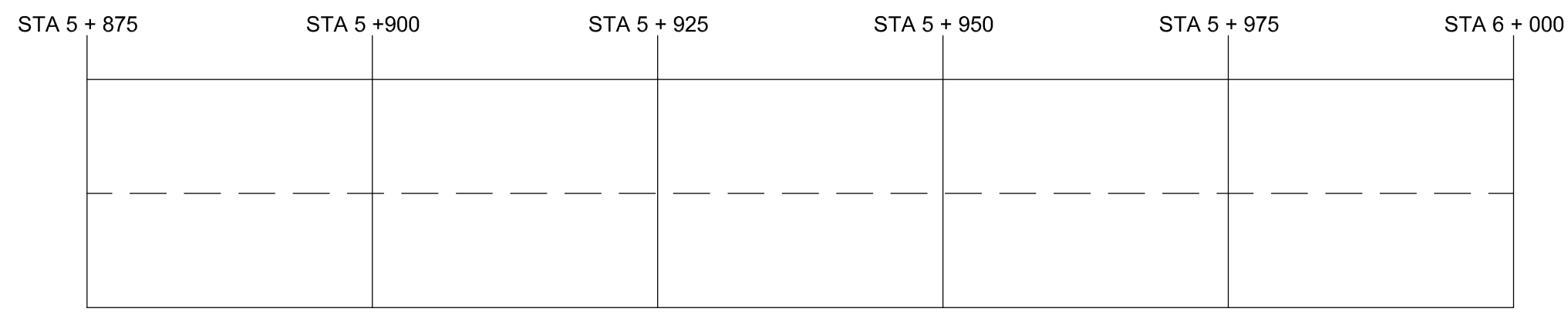

BADAN JALAN

[PENAMPANG LURUS]

Skala :
Horizontal : 1 : 50
Vertikal : 1 : 10

- KETERANGAN :**
- = Perkerasan Beton Fc' 25 Mpa dengan anyaman Tul. Tunggal Tbl. 20 cm
 - = AC-WC 4 cm
 - = AC-WC 4 cm dan AC-BC 6 cm
 - = Leveling / Normalisasi
 - = Berm Timbunan Pilihan dari sumber galian Tbl. 30 cm
 - = Talud Pasangan Batu



DINAS PEKERJAAN UMUM
DAN PERUMAHAN RAKYAT
KABUPATEN KARANGANYAR

No. Paket :-
No. Ruas : 112
Nama Ruas : Jl. Malangaten - Buntar
Provinsi : Jawa Tengah



CV. GEMILANG KONSULTAN

Digambar	Direncanakan	Diperiksa
MUKTI PUJI WIDODO, ST	BASUKI RAHMAT, ST	TEDDY KRESWANTO, ST

JUDUL GAMBAR :

STA 6 + 000 - STA 6 + 125

No Lembar : 52

Jml Lembar : 62

Skala : H 1 : 50
V 1 : 10

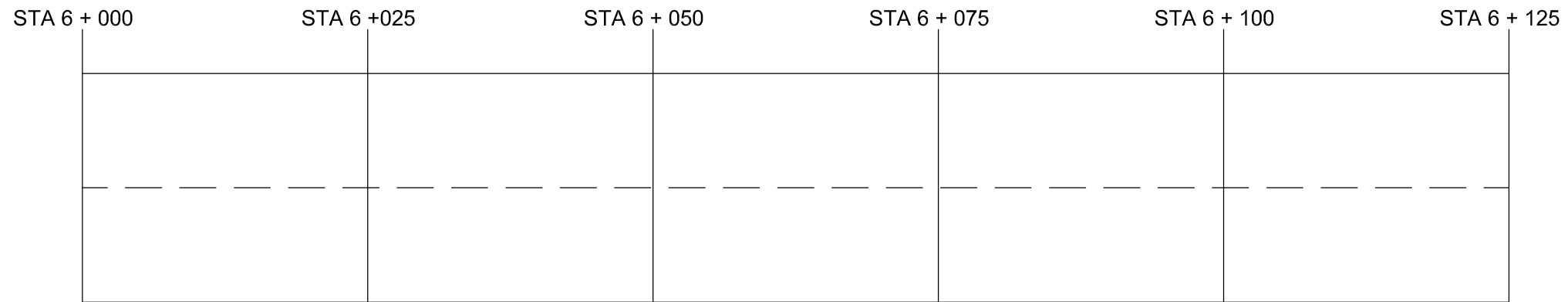

Berm

BADAN JALAN

[PENAMPANG LURUS]

Skala :
Horizontal : 1 : 50
Vertikal : 1 : 10

Berm

KETERANGAN :

- = Perkerasan Beton Fc' 25 Mpa dengan anyaman Tul. Tunggal Tbl. 20 cm
- = AC-WC 4 cm
- = AC-WC 4 cm dan AC-BC 6 cm
- = Leveling / Normalisasi
- = Berm Timbunan Pilihan dari sumber galian Tbl. 30 cm
- = Talud Pasangan Batu

STA 6 + 000

STA 6 +025

STA 6 + 050

STA 6 + 075

STA 6 + 100

STA 6 + 125



DINAS PEKERJAAN UMUM
DAN PERUMAHAN RAKYAT
KABUPATEN KARANGANYAR

No. Paket :-
No. Ruas : 112
Nama Ruas : Jl. Malangaten - Buntar
Provinsi : Jawa Tengah



CV. GEMILANG KONSULTAN

Digambar	Direncanakan	Diperiksa
MUKTI PUJI WIDODO, ST	BASUKI RAHMAT, ST	TEDDY KRESWANTO, ST

JUDUL GAMBAR :

STA 6 + 125 - STA 6 + 200

No Lembar : 53

Jml Lembar : 62

Skala : H 1 : 50
: V 1 : 10

STA 6 + 125

STA 6 + 150

STA 6 + 200

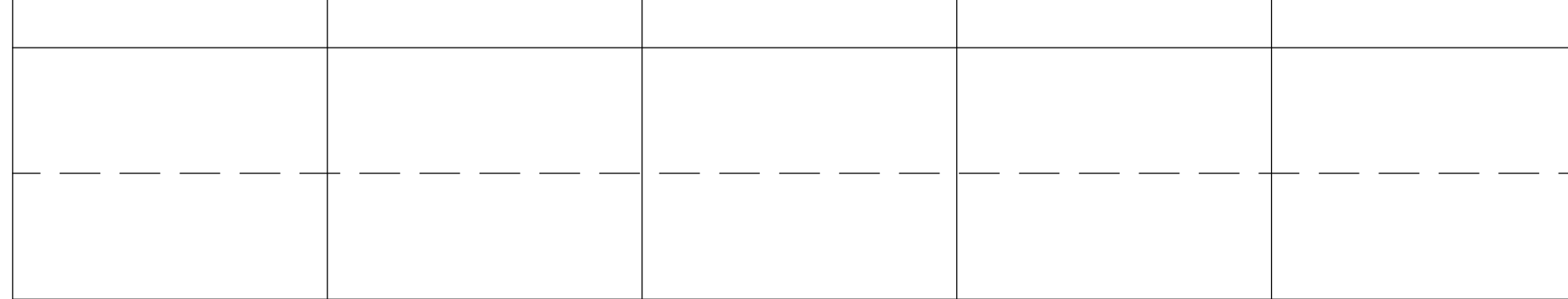

Berm

BADAN JALAN

[PENAMPANG LURUS]

Skala :
Horizontal : 1 : 50
Vertikal : 1 : 10

Berm

STA 6 + 125

STA 6 + 150

STA 6 + 200

KETERANGAN :

- = Perkerasan Beton Fc' 25 Mpa dengan anyaman Tul. Tunggal Tbl. 20 cm
- = AC-WC 4 cm
- = AC-WC 4 cm dan AC-BC 6 cm
- = Leveling / Normalisasi
- = Berm Timbunan Pilihan dari sumber galian Tbl. 30 cm
- = Talud Pasangan Batu



DINAS PEKERJAAN UMUM
DAN PERUMAHAN RAKYAT
KABUPATEN KARANGANYAR

No. Paket :-
No. Ruas : 112
Nama Ruas : Jl. Malangaten - Buntar
Provinsi : Jawa Tengah



CV. GEMILANG KONSULTAN

Digambar	Direncanakan	Diperiksa
MUKTI PUJI WIDODO, ST	BASUKI RAHMAT, ST	TEDDY KRESWANTO, ST

JUDUL GAMBAR :

TIPIKAL POTONGAN MELINTANG
ASPAL

No Lembar : 54

Jml Lembar : 62

Skala : 1:50

POTONGAN JALAN ASPAL
STA 0+400 - 0+525

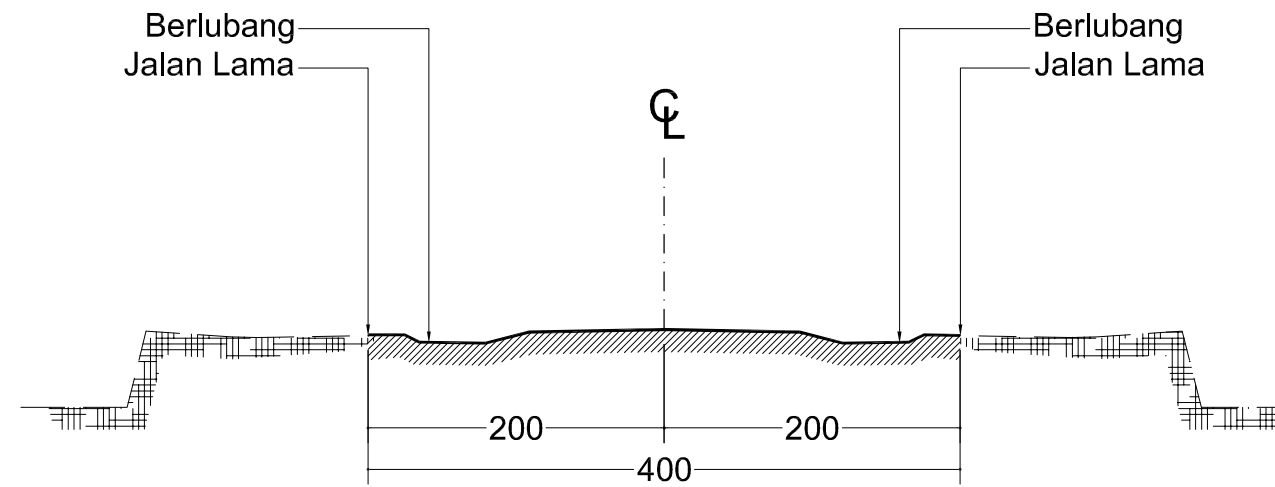

POT. EXISTING TYPICAL
Skala 1 : 50

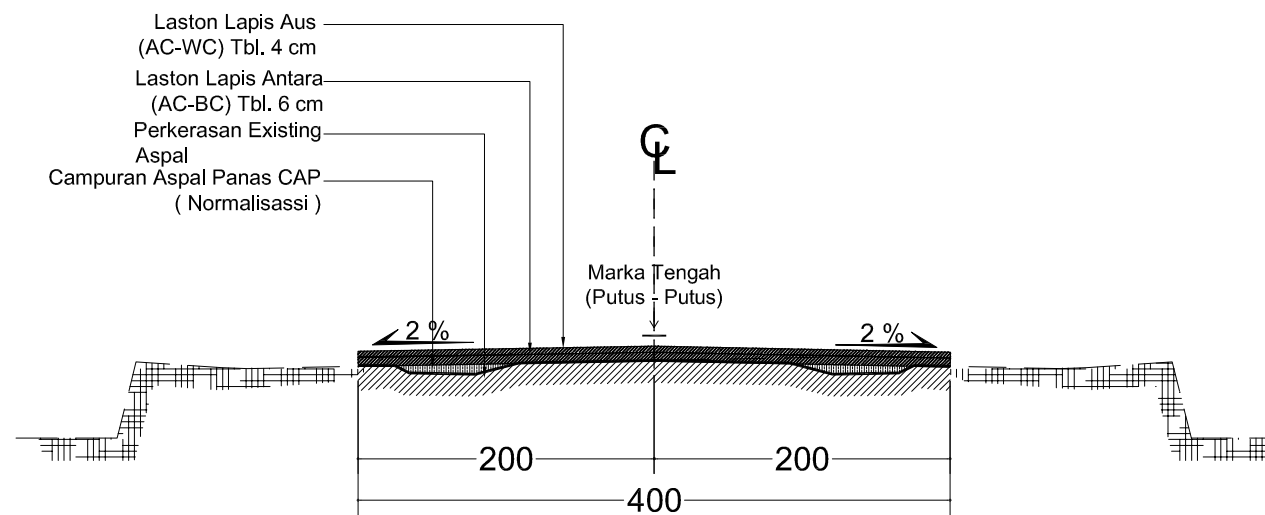

POT. RENCANA TYPICAL
Skala 1 : 50



DINAS PEKERJAAN UMUM
DAN PERUMAHAN RAKYAT
KABUPATEN KARANGANYAR

No. Paket :-
No. Ruas : 112
Nama Ruas : Jl. Malanggaten - Buntar
Provinsi : Jawa Tengah



CV. GEMILANG KONSULTAN

Digambar	Direncanakan	Diperiksa
MUKTI PUJI WIDODO, ST	BASUKI RAHMAT, ST	TEDDY KRESWANTO, ST

JUDUL GAMBAR :
TYPICAL POTONGAN MELINTANG
BETON

No Lembar : 55
Jml Lembar : 62
Skala : 1:50

POTONGAN JALAN BETON
STA 1+058 - 1+125

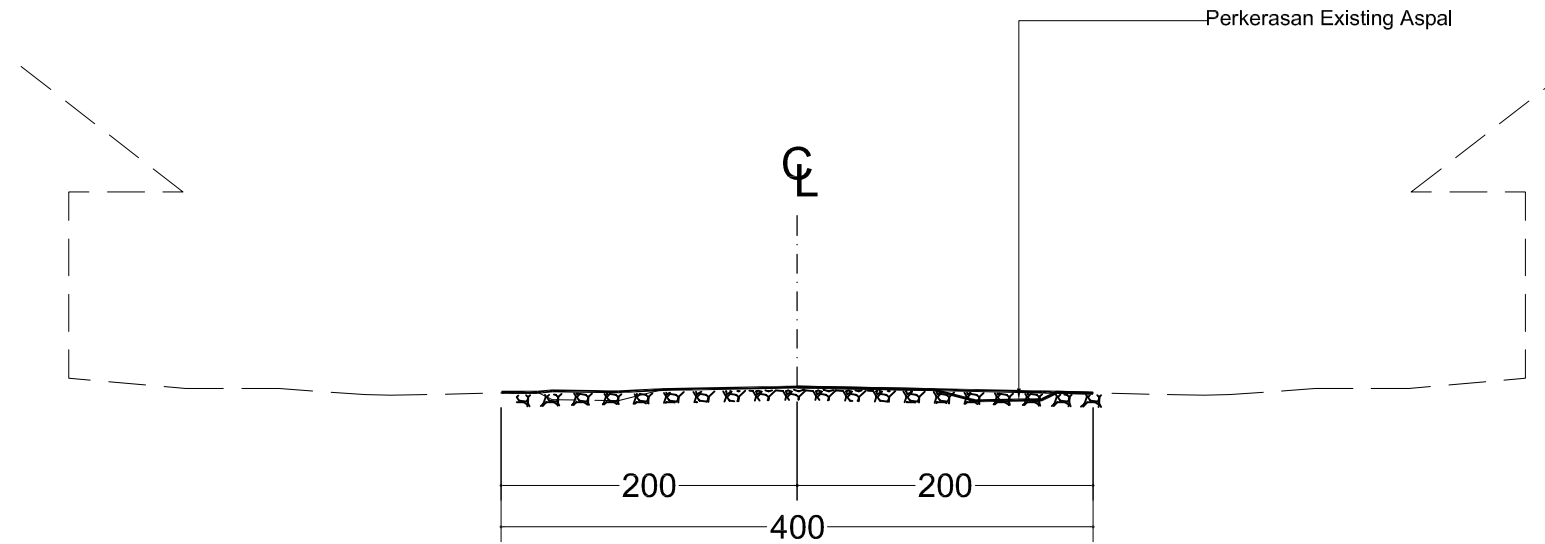

POT. EXISTING TYPICAL
Skala 1 : 50

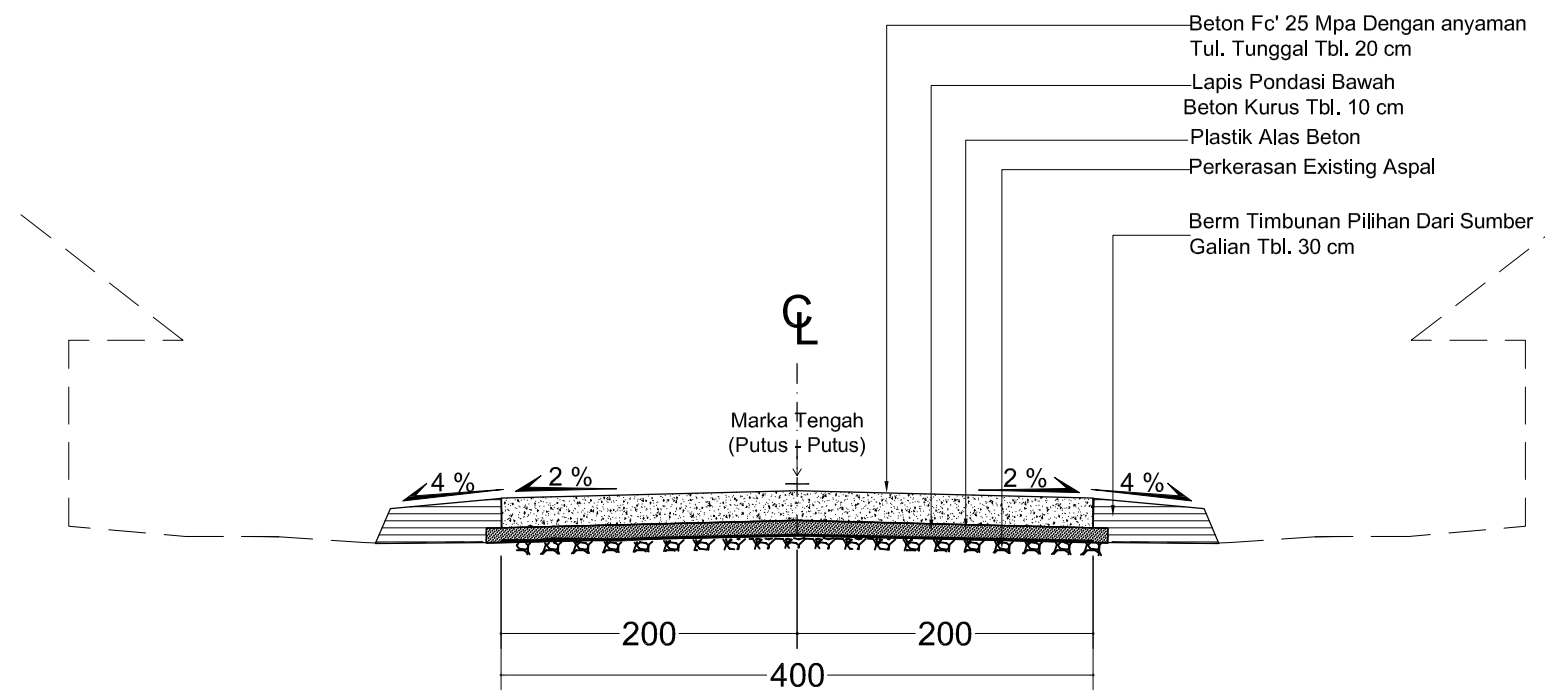

POT. EXISTING TYPICAL
Skala 1 : 50



DINAS PEKERJAAN UMUM
DAN PERUMAHAN RAKYAT
KABUPATEN KARANGANYAR

No. Paket :-
No. Ruas : 112
Nama Ruas : Jl. Malanggaten - Buntar
Provinsi : Jawa Tengah



CV. GEMILANG KONSULTAN
Digambar: MUKTI PUJI WIDODO, ST
Direncanakan: BASUKI RAHMAT, ST
Diperiksa: TEDDY KRESWANTO, ST

JUDUL GAMBAR :
TYPICAL POTONGAN MELINTANG
BETON

No Lembar : 55
Jml Lembar : 62
Skala : 1:50

POTONGAN JALAN BETON
STA 1+058 - 1+125

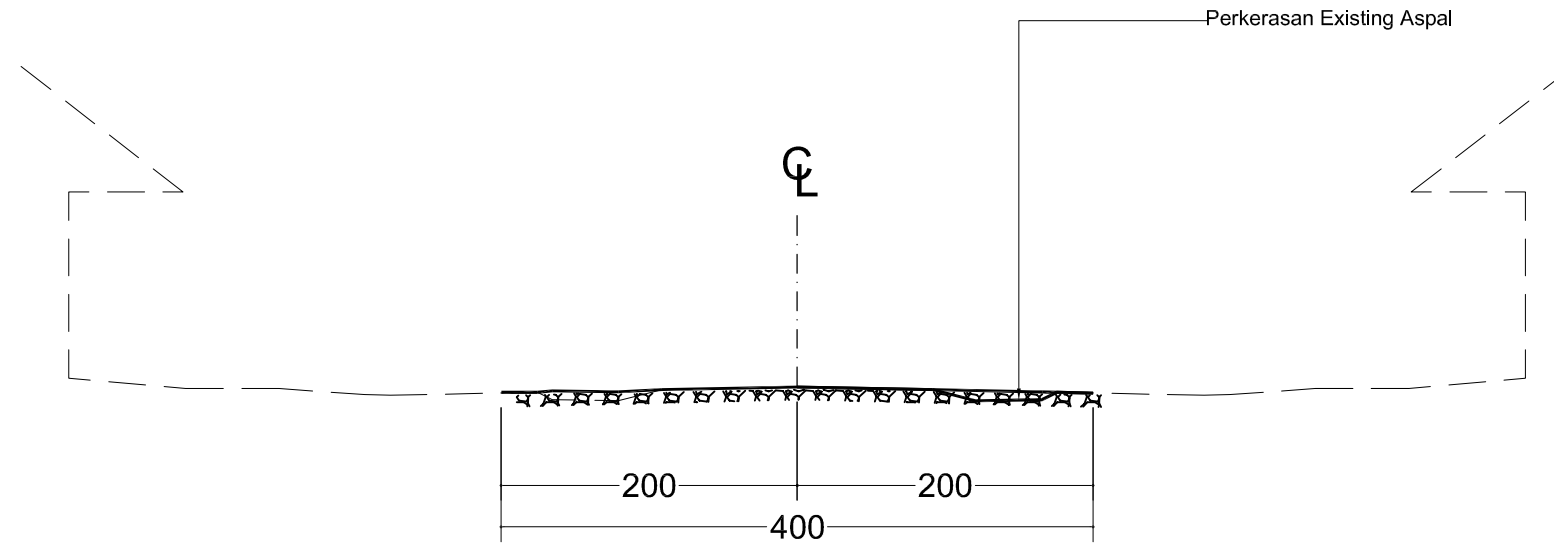

POT. EXISTING TYPICAL
Skala 1 : 50

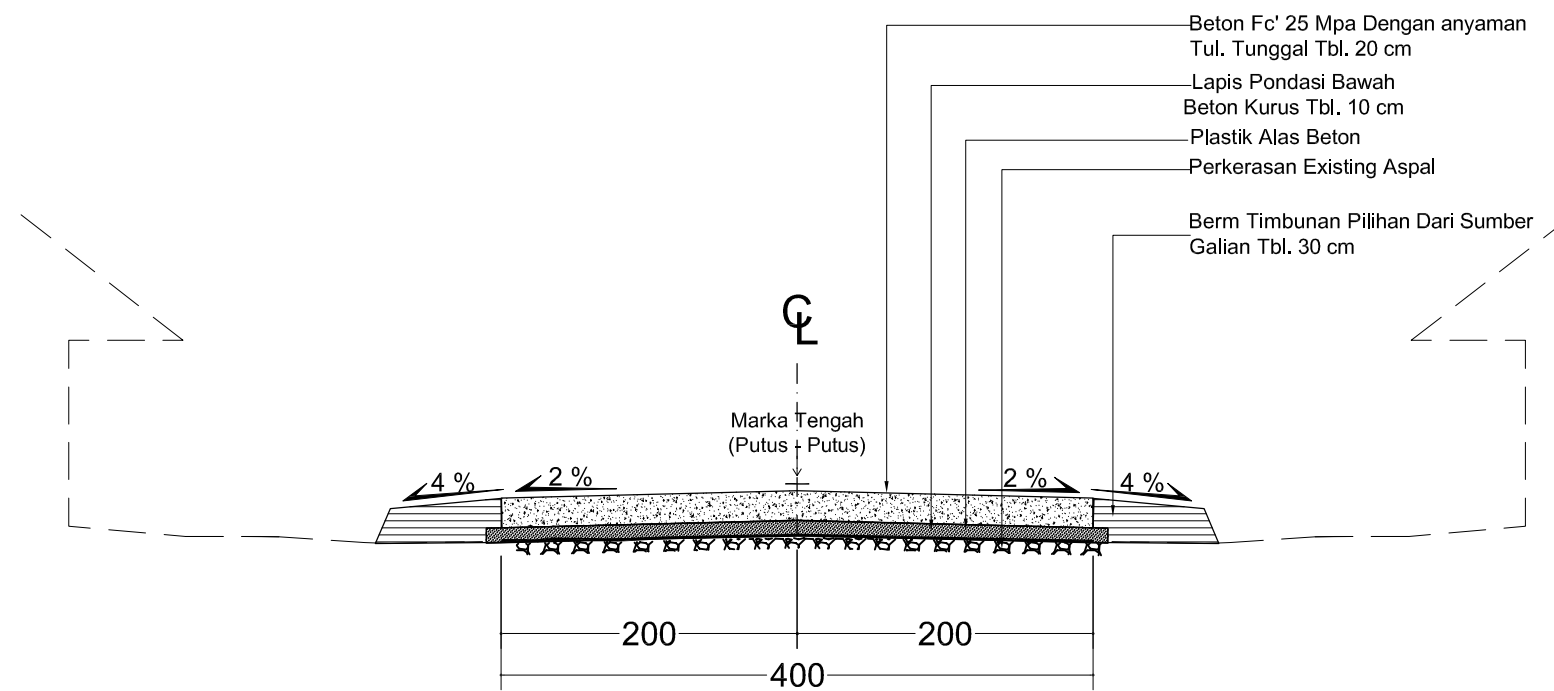

POT. EXISTING TYPICAL
Skala 1 : 50



DINAS PEKERJAAN UMUM
DAN PERUMAHAN RAKYAT
KABUPATEN KARANGANYAR

No. Paket :-
No. Ruas : 112
Nama Ruas : Jl. Malanggan - Buntar
Provinsi : Jawa Tengah



CV. GEMILANG KONSULTAN

Digambar	Direncanakan	Diperiksa
MUKTI PUJI WIDODO, ST	BASUKI RAHMAT, ST	TEDDY KRESWANTO, ST

JUDUL GAMBAR :
TYPICAL POTONGAN MELINTANG
BETON

No Lembar : 56
Jml Lembar : 62
Skala : 1:50

POTONGAN JALAN BETON
STA 1+437 - 2+950

POT. EXISTING TYPICAL
Skala 1 : 50

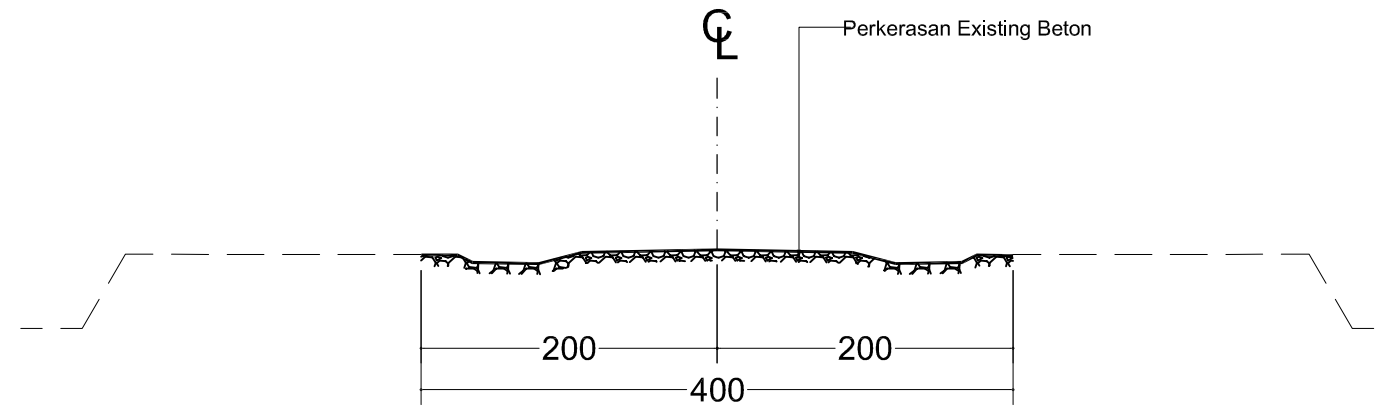

POT. EXISTING TYPICAL
Skala 1 : 50

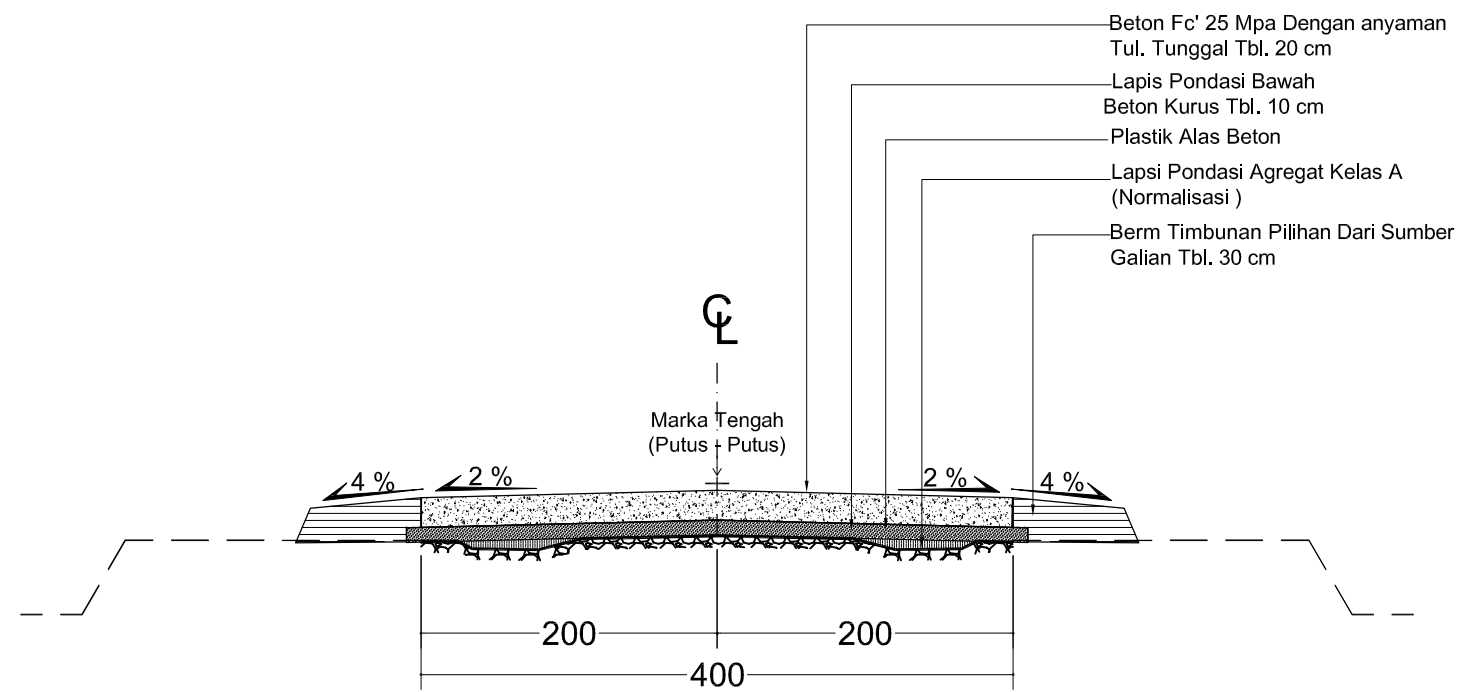



DINAS PEKERJAAN UMUM
DAN PERUMAHAN RAKYAT
KABUPATEN KARANGANYAR

No. Paket :-
No. Ruas : 112
Nama Ruas : Jl. Malanggan - Buntar
Provinsi : Jawa Tengah



CV. GEMILANG KONSULTAN

Digambar	Direncanakan	Diperiksa
MUKTI PUJI WIDODO, ST	BASUKI RAHMAT, ST	TEDDY KRESWANTO, ST

JUDUL GAMBAR :
TYPICAL POTONGAN MELINTANG
BETON

No Lembar : 56
Jml Lembar : 62
Skala : 1:50

POTONGAN JALAN BETON
STA 1+437 - 2+950

POT. EXISTING TYPICAL
Skala 1 : 50

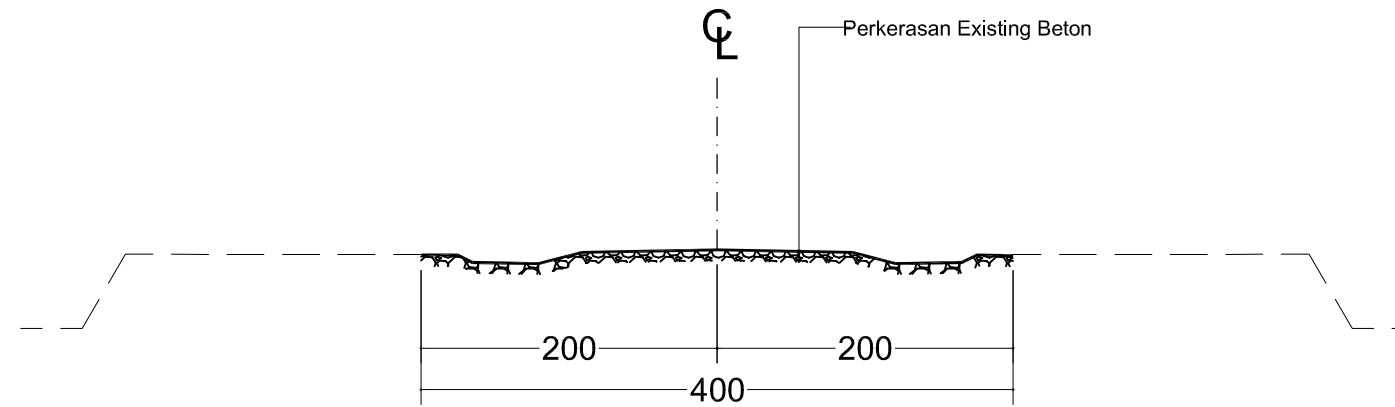

POT. EXISTING TYPICAL
Skala 1 : 50

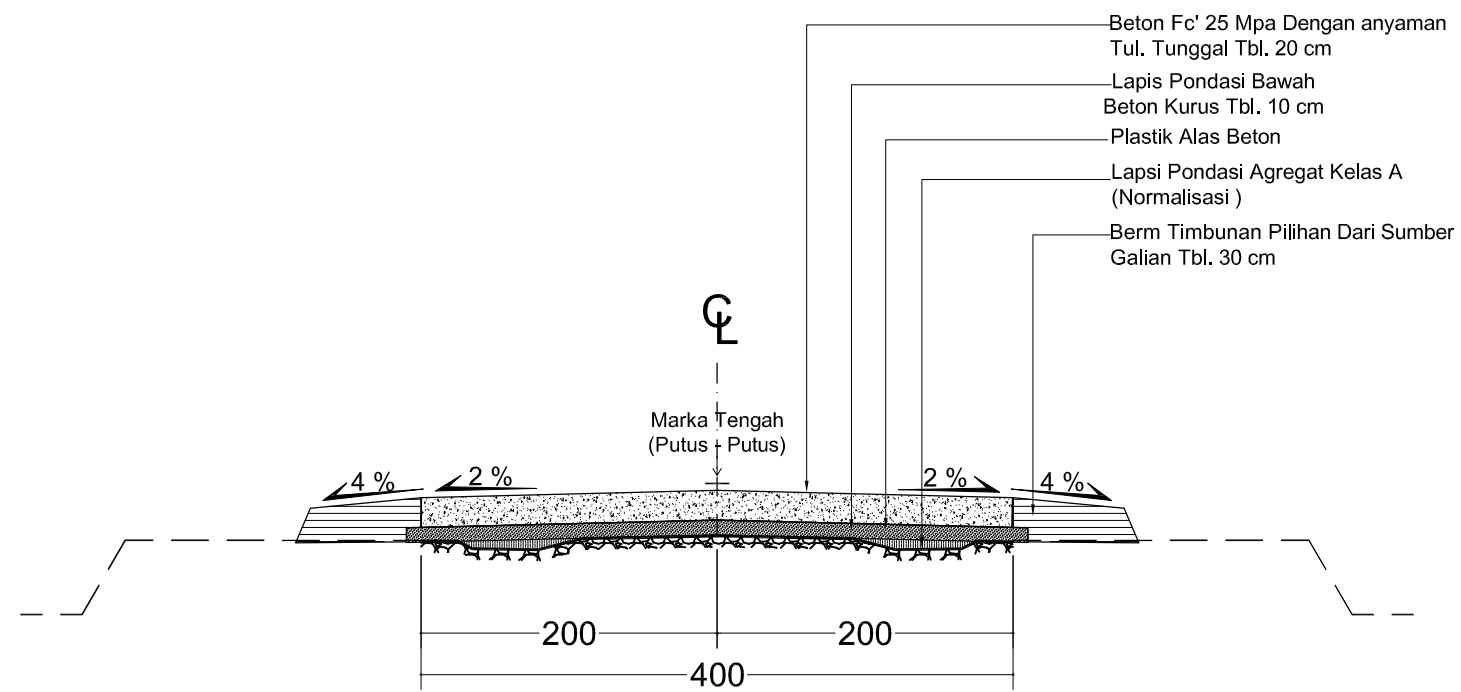



DINAS PEKERJAAN UMUM
DAN PERUMAHAN RAKYAT
KABUPATEN KARANGANYAR

No. Paket : -
No. Ruas : 112
Nama Ruas : Jl. Malanggan - Buntar
Provinsi : Jawa Tengah



CV. GEMILANG KONSULTAN

Digambar	Direncanakan	Diperiksa
MUKTI PUJI WIDODO, ST	BASUKI RAHMAT, ST	TEDDY KRESWANTO, ST

JUDUL GAMBAR :

TYPIKAL POTONGAN MELINTANG
ASPAL

No Lembar : 57

Jml Lembar : 62

Skala : 1:50

POTONGAN JALAN ASPAL
STA 2+950 - 4+600
STA 5+173 - 5+650

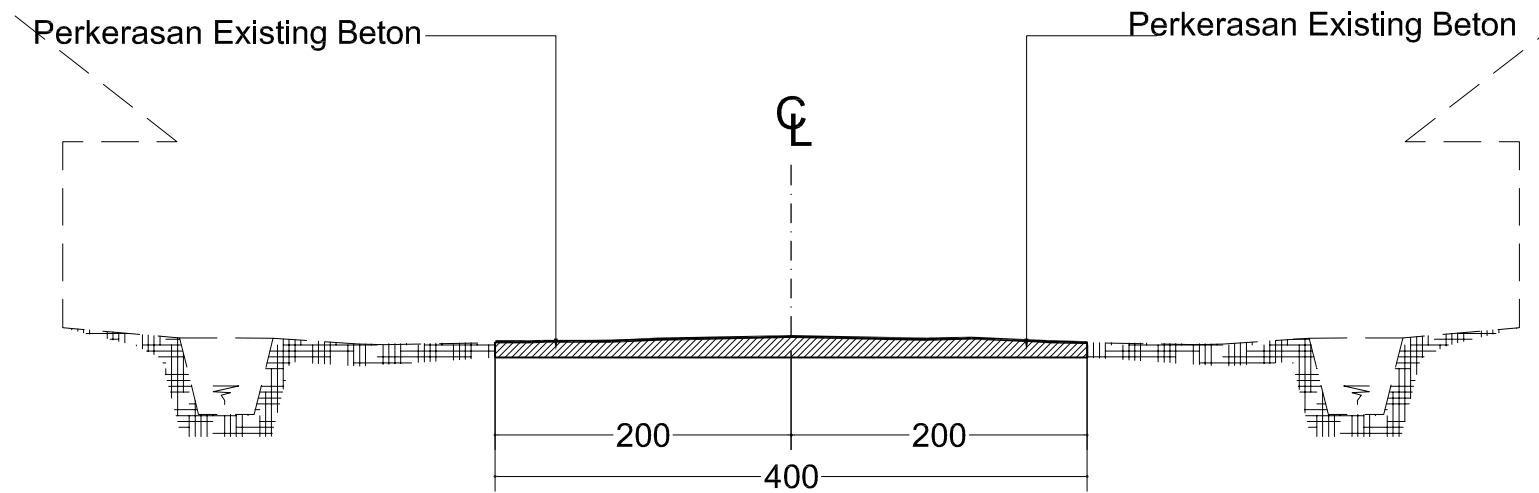

POT. EXISTING TYPICAL
Skala 1 : 50

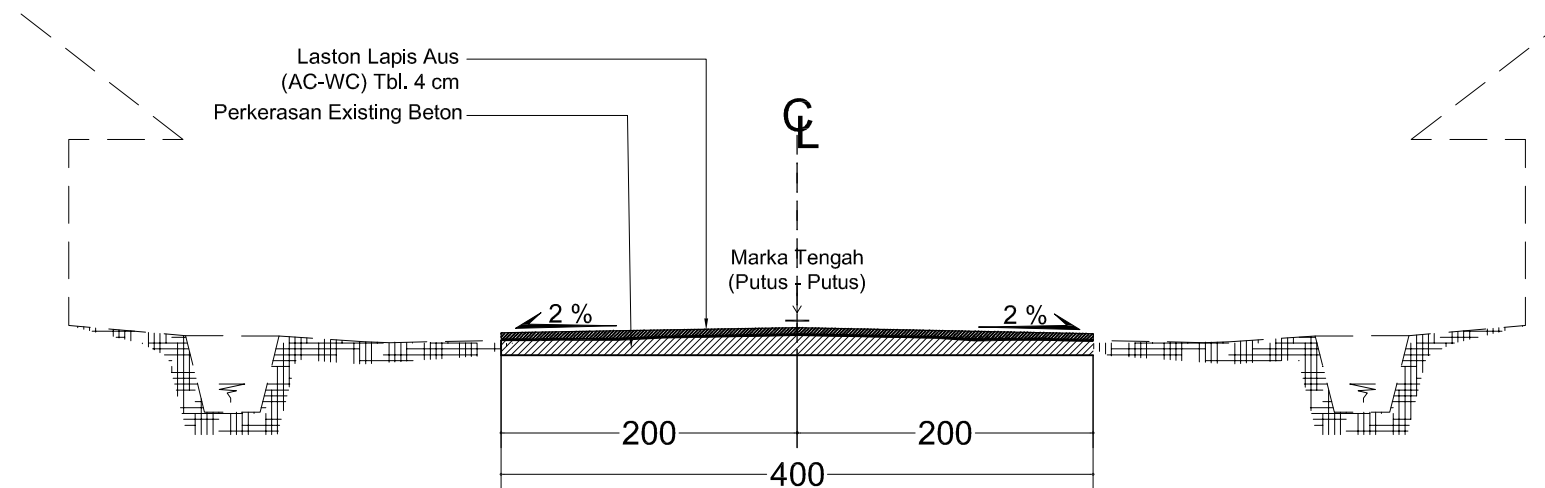

POT. RENCANA TYPICAL
Skala 1 : 50



DINAS PEKERJAAN UMUM
DAN PERUMAHAN RAKYAT
KABUPATEN KARANGANYAR

No. Paket :-
No. Ruas : 112
Nama Ruas : Jl. Malangaten - Buntar
Provinsi : Jawa Tengah



CV. GEMILANG KONSULTAN

Digambar	Direncanakan	Diperiksa
MUKTI PUJI WIDODO, ST	BASUKI RAHMAT, ST	TEDDY KRESWANTO, ST

JUDUL GAMBAR :

TYPIKAL POTONGAN MELINTANG
BETON

No Lembar : 58

Jml Lembar : 62

Skala : 1:50

POTONGAN JALAN BETON
STA 4+600 - 5+173

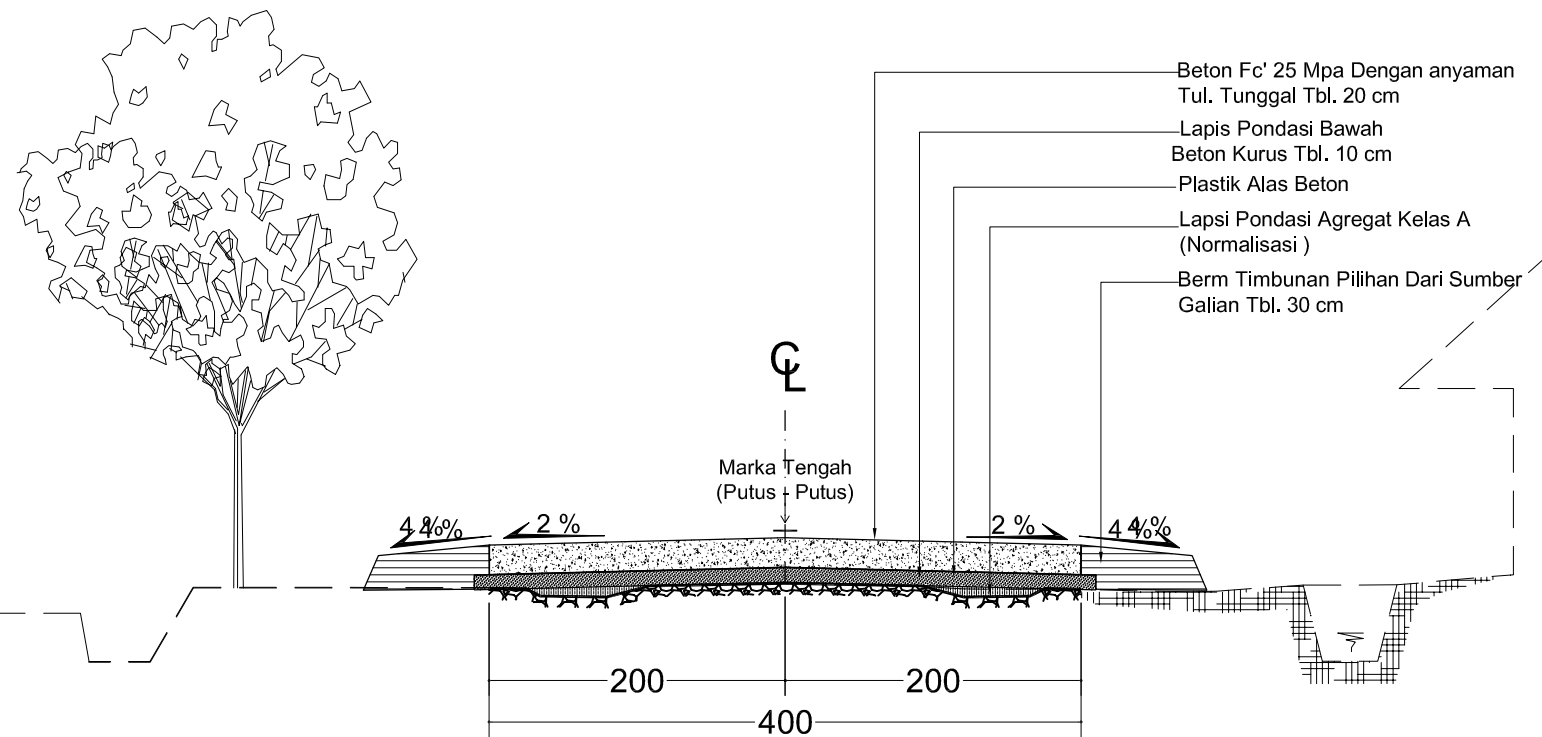
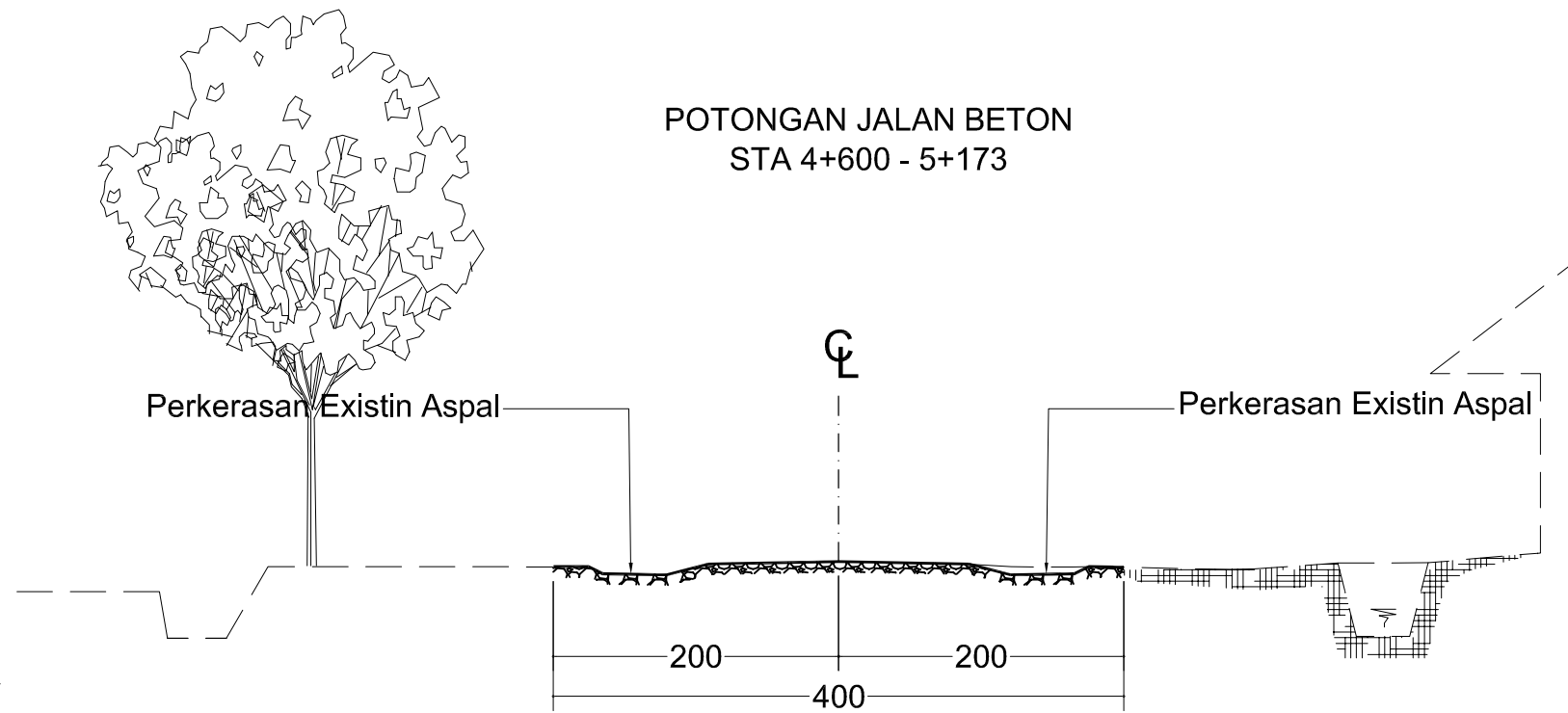



DINAS PEKERJAAN UMUM
DAN PERUMAHAN RAKYAT
KABUPATEN KARANGANYAR

No. Paket :-
No. Ruas : 112
Nama Ruas : Jl. Malanggan - Buntar
Provinsi : Jawa Tengah



CV. GEMILANG KONSULTAN

Digambar	Direncanakan	Diperiksa
MUKTI PUJI WIDODO, ST	BASUKI RAHMAT, ST	TEDDY KRESWANTO, ST

JUDUL GAMBAR :

TYPIKAL POTONGAN MELINTANG
BETON

No Lembar : 58

Jml Lembar : 62

Skala : 1:50

POTONGAN JALAN BETON
STA 4+600 - 5+173

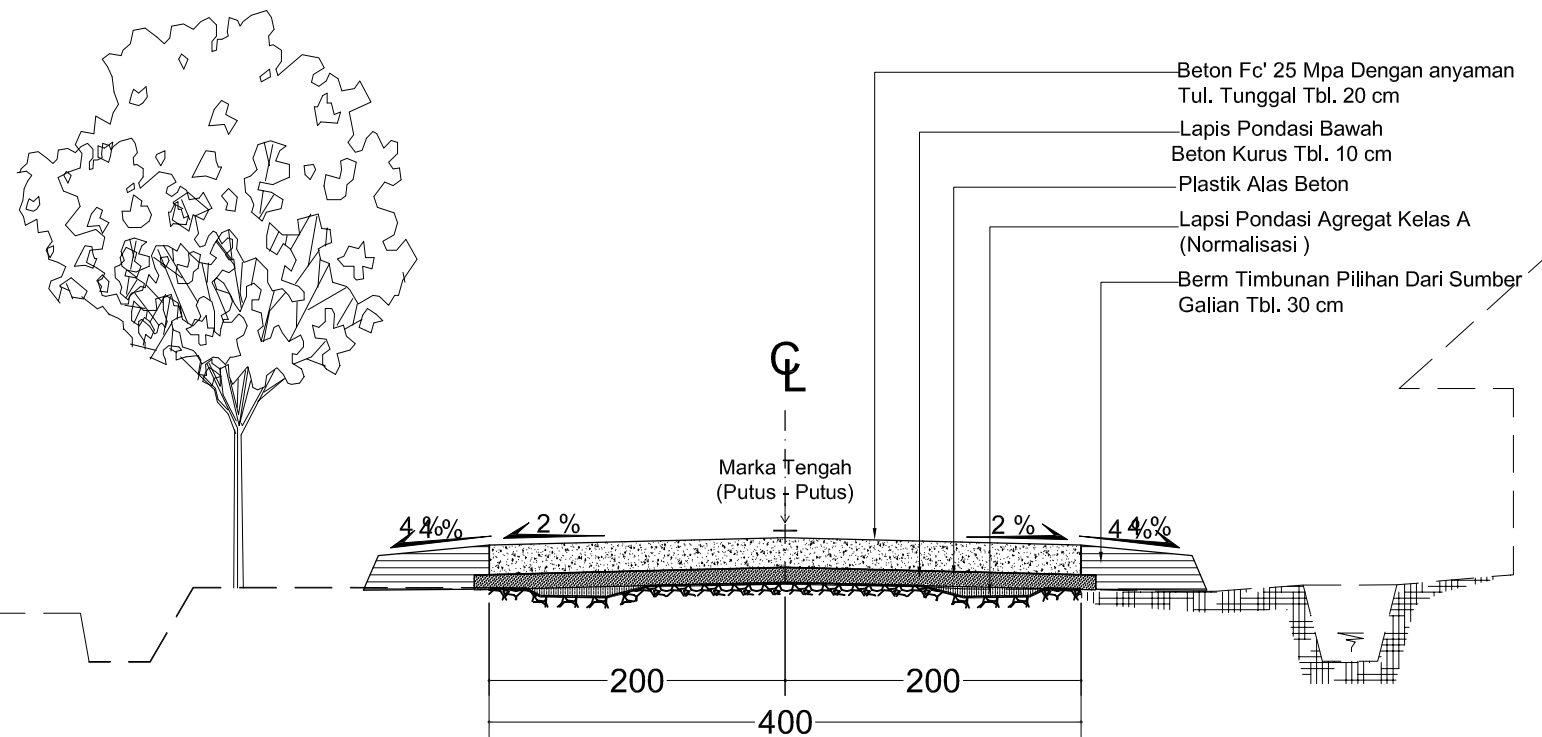
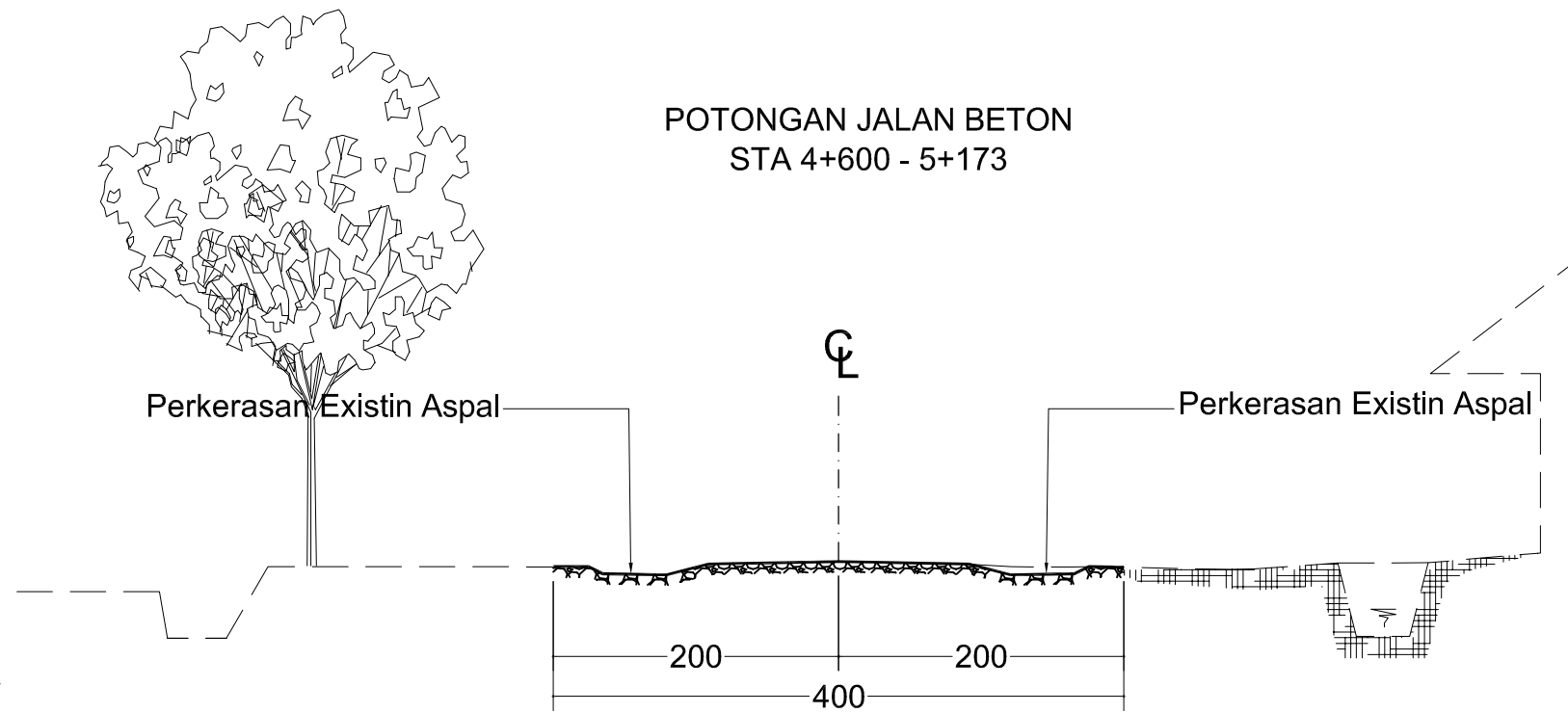



DINAS PEKERJAAN UMUM
DAN PERUMAHAN RAKYAT
KABUPATEN KARANGANYAR

No. Paket :-
No. Ruas : 112
Nama Ruas : Jl. Malanggan - Buntar
Provinsi : Jawa Tengah



CV. GEMILANG KONSULTAN

Digambar	Direncanakan	Diperiksa
MUKTI PUJI WIDODO, ST	BASUKI RAHMAT, ST	TEDDY KRESWANTO, ST

JUDUL GAMBAR :

DETAIL PEMASANGAN DOWEL

No Lembar : 60

Jml Lembar : 62

Skala : 1 : 10

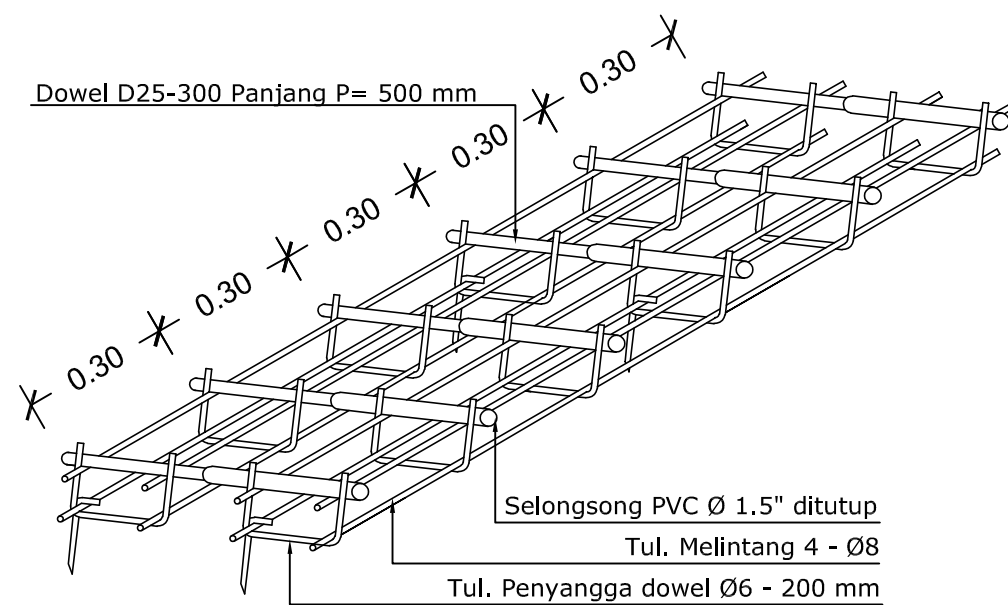
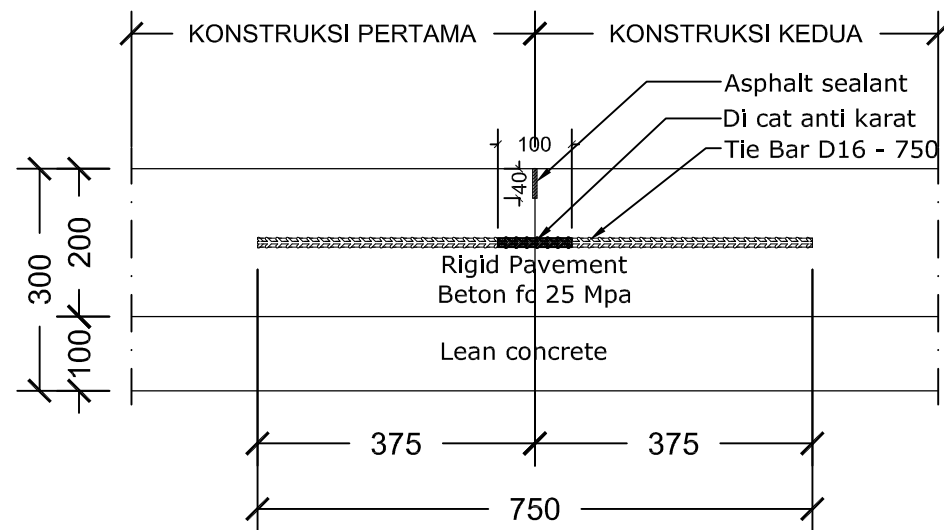
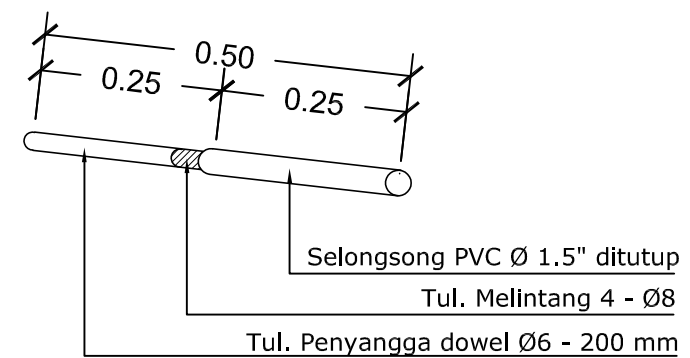
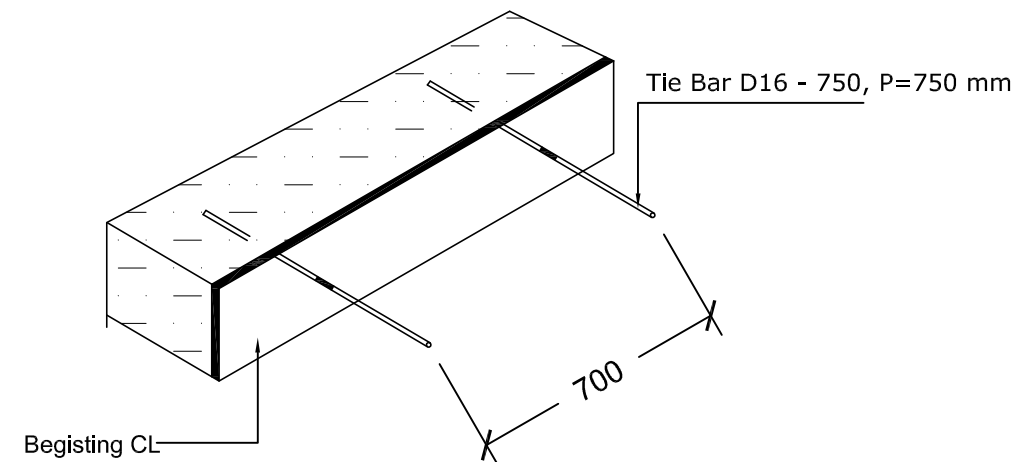
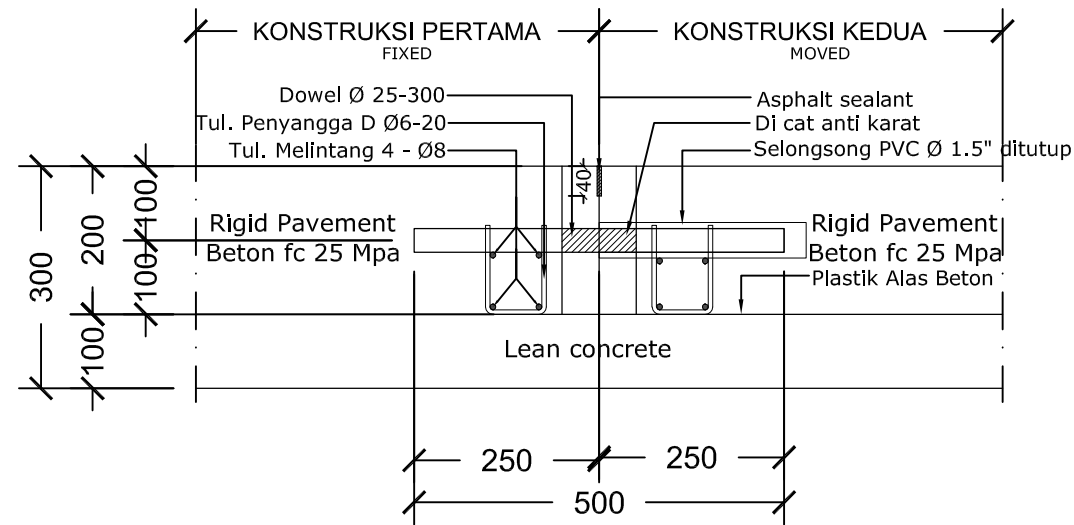

ISOMETRI PEMASANGAN DOWEL
SKALA 1 : 10



DINAS PEKERJAAN UMUM
DAN PERUMAHAN RAKYAT
KABUPATEN KARANGANYAR

No. Paket : -
No. Ruas : 112
Nama Ruas : Jl. Malanggan - Buntar
Provinsi : Jawa Tengah



CV. GEMILANG KONSULTAN

Digambar	Direncanakan	Diperiksa
MUKTI PUJI WIDODO, ST	BASUKI RAHMAT, ST	TEDDY KRESWANTO, ST

JUDUL GAMBAR :

DETAIL MODUL DOWEL

No Lembar : 59

Jml Lembar : 62

Skala : 1 : 100

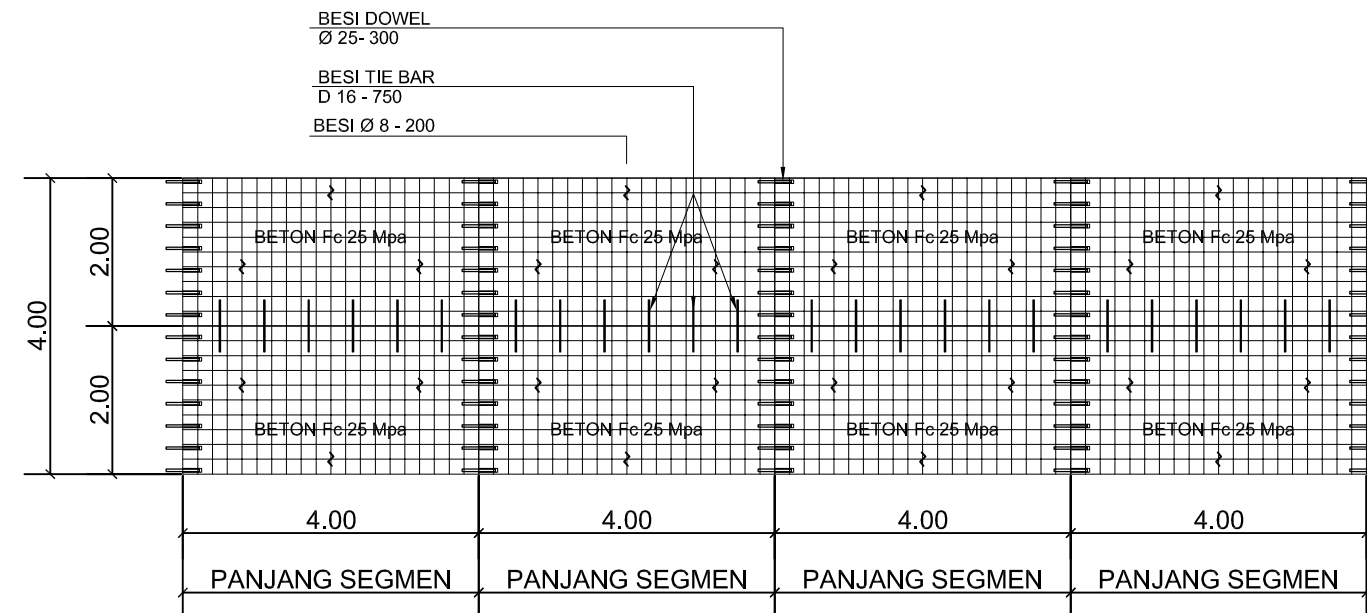

DETAIL MODUL DOWEL
Skala 1 : 100



DINAS PEKERJAAN UMUM
DAN PERUMAHAN RAKYAT
KABUPATEN KARANGANYAR

No. Paket :-
No. Ruas : 112
Nama Ruas : Jl. Malangaten - Buntar
Provinsi : Jawa Tengah



CV. GEMILANG KONSULTAN

Digambar	Direncanakan	Diperiksa
MUKTI PUJI WIDODO, ST	BASUKI RAHMAT, ST	TEDDY KRESWANTO, ST

JUDUL GAMBAR :

DETAIL OPRIT JALAN MASUK
TYPE 1

No Lembar : 61

Jml Lembar : 62

Skala : 1 : 100

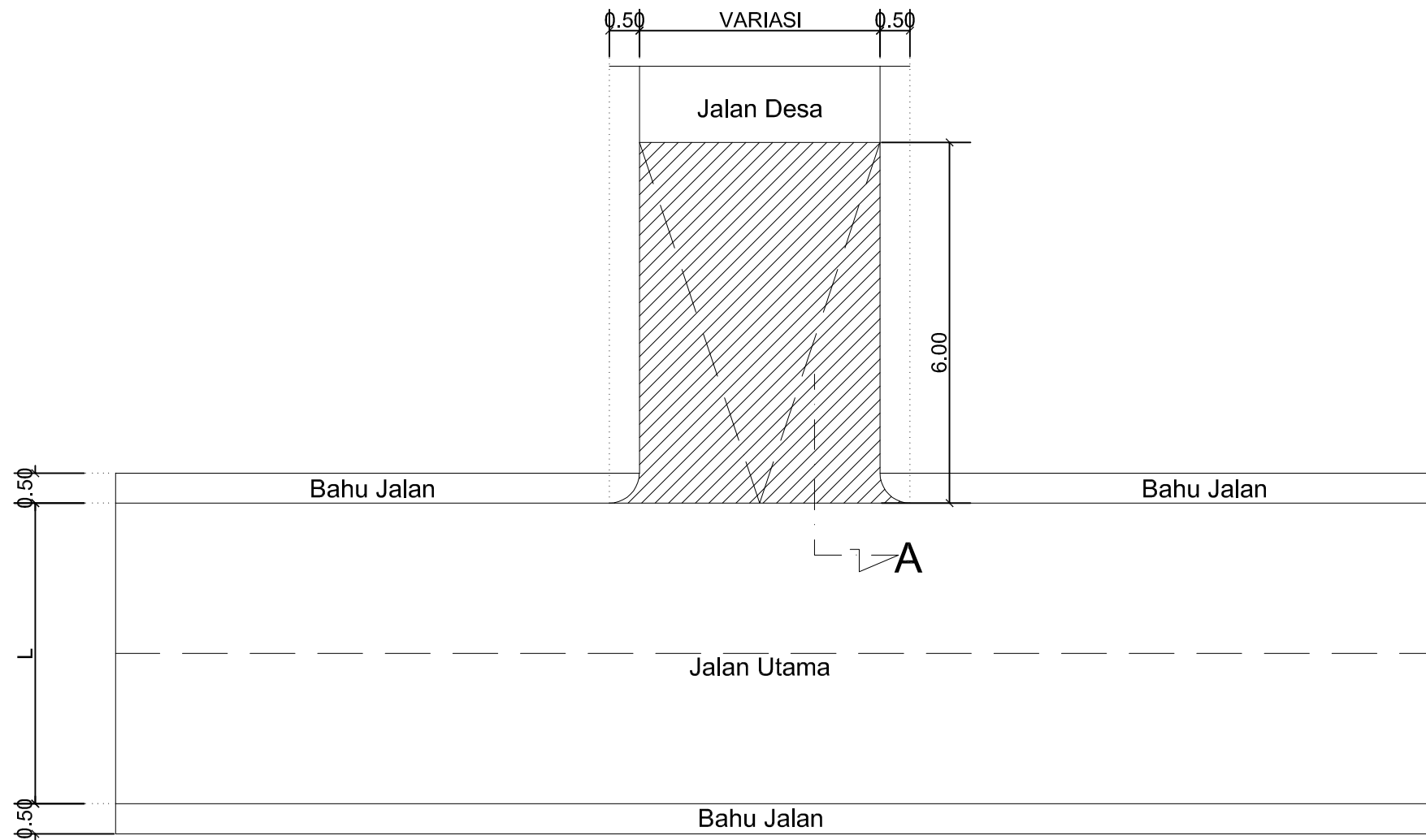

DETAIL OPRIT JALAN MASUK TYPE 1
Skala 1 : 100

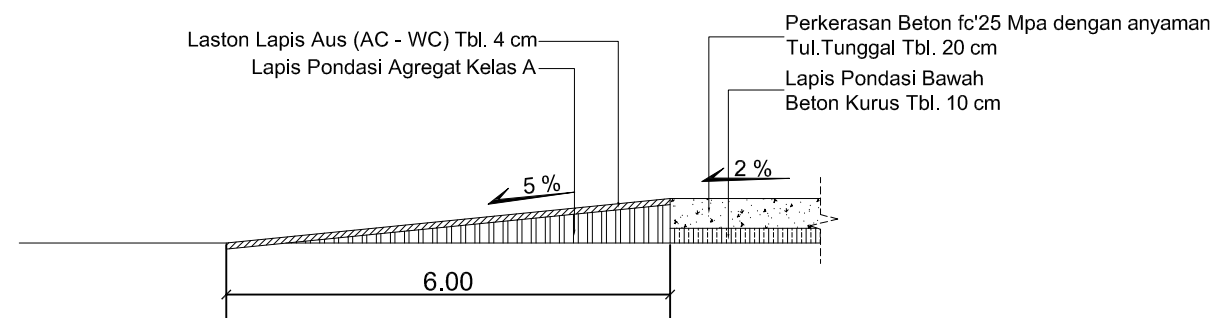

POTONGAN A OPRIT JALAN MASUK BETON TYPE 1
Skala 1 : 100

